

TEXT BOOK FOR

SR.SECONDARY COURSE

# PAINTING



BOARD OF SCHOOL EDUCATION HUBLI, KARNATAKA

ಬೋರ್ಡ್ ಆಫ್ ಸ್ಕೂಲ್ ಎಜುಕೇಶನ್ ಹುಬ್ಬಳ್ಳಿ, ಕರ್ನಾಟಕ



Upper Ground Floor, IT Park, Deshpande Nagar



0836-4061132



[www.bseh.ac.in](http://www.bseh.ac.in)



[contact@bseh.ac.in](mailto:contact@bseh.ac.in)

## CONTENT - A

<b>NO.</b>	<b>CHAPTER</b>	<b>PAGE NO.</b>
<b>MODULE - 1</b>		
1	ARTS OF INDUS VALLEY CIVILIZATION	1 - 10
2	ARTS FROM MAURYA TO GUPTA PERIOD	11 - 24
3	AJANTA CAVES	25 - 30
4	TEMPLE ART AND SCULPTURE	31 - 38
5	INDIAN BRONZES	39 - 46
6	INDO-ISLAMIC ARCHITECTURE	47 - 54
7	MUGHAL SCHOOL	55 - 66
8	RAJASTHANI SCHOOL OF PAINTING	67 - 76
9	PAHARI SCHOOL OF MINIATURE PAINTING	77 - 82
10	DECCAN SCHOOL OF PAINTING	83 - 88
11	COMPANY SCHOOL	89 - 94
12	PIONEERS OF CONTEMPORARY ART MOVEMENTS IN INDIA	95 - 105
13	CONTEMPRARY ART OF INDIA	106 - 117
14	FOLK PAINTING	118 - 129
<b>MODULE - 2</b>		
1	OBJECT DRAWING	1 - 17
2	NATURE STUDY	18 - 27
3	FUNDAMENTAL OF PAINTING	28 - 42
4	COMPOSITION	43 - 51
5	SKETCHING FROM LIFE AND MEMORY	52 - 66
6	FOLK ART IS A MOTIF	67 - 73



332en01

# 1

## Art of Indus Valley Civilization

### 1.0 INTRODUCTION

The first discoveries of the Indus Valley Civilization were made at the site of Harappa near Sindh province (Now in Pakistan). Thus it is also known as Harappa Civilization. Later excavations prove that the civilization had far greater extension to Mohanjo-Daro and other cities.

Lot of art and craft objects have been discovered from these sites during excavations. These include statuettes, toys, seals, jewellery, pottery and tools. Most scholars believe this civilization had flourished between 2500 B.C. to 1750 B.C.

An attempt will be made to impart knowledge about the arts and crafts of this period by selecting four art works for the lessons.

### 1.1 OBJECTIVES

After studying this lesson the learner will be able to:

- know about the date of Harappa civilization;
- name the artwork which are mentioned in this lesson;
- describe the site of finding, size, style, colour, and place of collection of the enlisted art objects;
- mention the main characteristics of the enlisted art-objects of this period;
- differentiate and identify characteristics of the enlisted art works.



*Mother Goddess*





*Seal with Bull Design*

### 1.3 SEAL WITH BULL DESIGN

<i>Title</i>	-	<i>Seal with Bull Design</i>
<i>Medium</i>	-	<i>Steatite</i>
<i>Date</i>	-	<i>Harappa period circa 2500 B.C.</i>
<i>Finding site</i>	-	<i>Mohanjo-Daro</i>
<i>Size</i>	-	<i>2.5X2.5X1.4.cm.</i>
<i>Artist</i>	-	<i>Unknown</i>
<i>Collection</i>	-	<i>National Museum, New Delhi</i>

#### General Description

The seal is made of steatite and has an elaborate intaglio design of a bull as a symbol of power and strength, which has been achieved by exaggerating the size of the hump and the horns. The diagonal linear motif of the neck express the youthful energy of the animal.

There are some writings on the upper part of the seal, which are not yet deciphered.

---

#### INTEXT QUESTIONS (1.3)

---

Choose the right answer.

- (a) The seal is made of
- (i) clay
  - (ii) stone dust
  - (iii) steatite
- (b) This seal was found at
- (i) Harappa
  - (ii) Mohanjo-Daro
  - (iii) Chanho-Daro
-



*Painted Pottery*

## 1.4 PAINTED POTTERY

<i>Title</i>	-	<i>Storage Jar</i>
<i>Medium</i>	-	<i>Clay</i>
<i>Date</i>	-	<i>Harappa period circa 2500 B.C.</i>
<i>Finding site</i>	-	<i>Mohanjo-Daro</i>
<i>Size</i>	-	<i>Height 21¾"</i>
<i>Artist</i>	-	<i>Unknown</i>
<i>Collection</i>	-	<i>National Museum, New Delhi</i>

### General Description

This jar is made on a Potters wheel with clay. The shape was manipulated by the pressure of the crafty fingers of the Potter. After baking the clay model, it was painted with black colour. The motifs are of vegetals and geometric forms. Designs are simple but with a tendency towards abstraction. High polished is used as a finishing touch.

### INTEXT QUESTION (1.4)

Choose the right answer:-

- (a) The Jar is made
- (i) with Tools
  - (ii) on Potter's wheel
  - (iii) with Chisel
- (b) The date of the Jar is
- (i) 1st C.A.D.
  - (ii) 6th C.A.D.
  - (iii) circa 2500 B.C
- (c) The size of the jar is
- (i) 24½"
  - (ii) 21¾"
  - (iii) 30¾"

## 1.2 MOTHER GODDESS

<i>Title</i>	-	<i>Mother Goddess</i>
<i>Medium</i>	-	<i>Terra cotta</i>
<i>Date</i>	-	<i>Harappa period circa 2500 B.C</i>
<i>Finding site</i>	-	<i>Mohanjo-Daro</i>
<i>Size</i>	-	<i>8.5X3.4.cm</i>
<i>Artist</i>	-	<i>Unknown</i>
<i>Collection</i>	-	<i>National Museum, New Delhi</i>

### General Description

This statue is made of clay and then baked in fire as per the terra cotta process. This figurine is one of the finest example of terra cotta. The baking is perfectly done to achieve an unblemished red colour. Some scholars have identified it as "mother goddess".

The headgear of this statue, interestingly, comprises of two small bowl-like forms on both sides of the head. These were probably used as lamps. These are again balanced by another form in the middle of the head which is supposed to be an elaborate hair-style. The figure is wearing a miniskirt with a broad belt to hold it in place. The figure is adorned with all kinds of jewellery.

### INTEXT QUESTION (1.2)

#### (1) Fill up the blanks

- The Mother Goddess statue is made of ".....".
- This was found at the site of ".....".
- The figure is wearing a ".....".

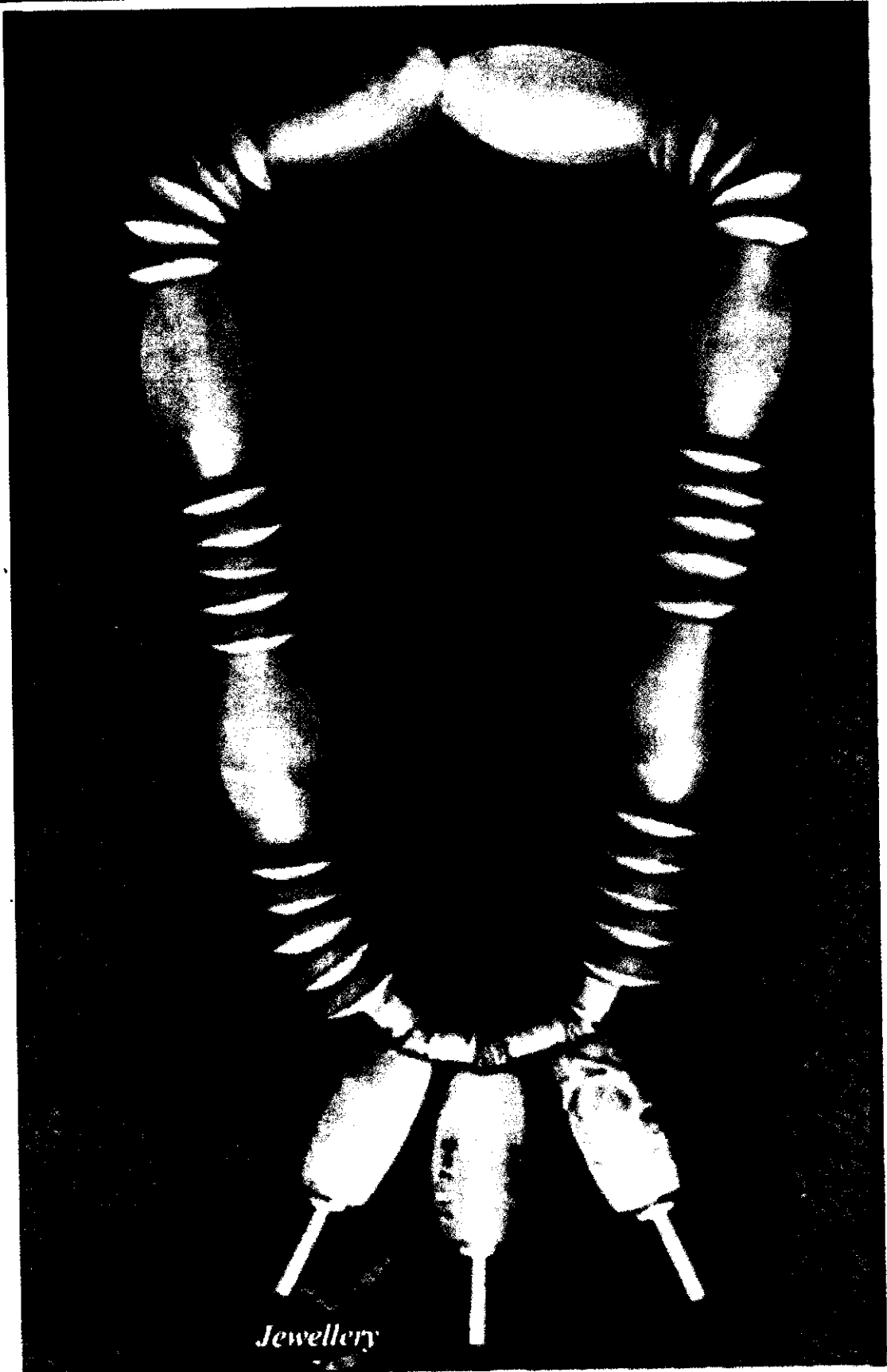

*Jewellery*

## 1.5 JEWELLERY

<i>Title</i>	-	<i>Jade Necklace</i>
<i>Medium</i>	-	<i>Jade</i>
<i>Date</i>	-	<i>Harappa period circa 2500 B.C.</i>
<i>Finding site</i>	-	<i>Mohanjo-Daro</i>
<i>Size</i>	-	<i>Diameter 5.5cm.</i>
<i>Artist</i>	-	<i>Unknown</i>
<i>Collection</i>	-	<i>National Museum, New Delhi</i>

### General Description

Jewellery was found in great abundance and variety at Indus Valley sites. Lot of Gold, Silver or Jade Necklace, ear rings, pendants, belts and bangles were found.

This Jade Necklace is an excellent example of craftsmanship and designing. This is made of 30 round beads and six oval beads. Three lockets in the middle part of the Necklace enhance its beauty.

---

### INTEXT QUESTIONS (1.5)

---

Choose the right answer

- (a) The necklace is made of
- (i) Diamond
  - (ii) Ruby
  - (iii) Jade
- (b) The number of lockets are
- (i) Two
  - (ii) Five
  - (iii) Three
- (c) Now it is in the collection of
- (i) Indian Museum, Kolkata
  - (ii) National Museum, New Delhi
  - (iii) Lahore Museum, Pakistan
-

## 1.6 SUMMARY

The artists and craftsmen of Harappa culture were extremely skilled in handling all kinds of material like metal, stone carving terra cotta and painting pottery. These artists preferred to use simplified motifs of animals, birds and plants. It is very clear that they were influenced and motivated by their religious beliefs and the cult of Siva and Shakti is very prominent in all their artworks.

---

## 1.7 ANSWER OF INTEXT QUESTION

---

1.2 (a) Terracotta (b) Mohanjo-Daro (c) Mini-skirt

1.3 (a) Steatite (b) Mohanjo-Daro

1.4 (a) Potter's wheel (b) Ca. 2500 B.C  
(c) 51 cm

1.5 (a) Jade (b) Three  
(c) National Museum, New Delhi

---

## 1.8 MODEL QUESTIONS

---

1. Write an appreciative note on any one artworks of Indus Valley civilization.
2. What do you know about terracotta?
3. Describe some features of Indus Valley Art.

---

## 1.9 GLOSSARY

Steatite	-	Soapstone
Intaglio	-	incised carving
Diagonal	-	going from corner to other corner.
Motif	-	form, shape, figures in a design
Deciphered	-	To read a new script
Baking	-	To give permanency to clay by the heat of fire
Jade	-	Dark green precious stone
Terracotta	-	Hard fired clay
Cult	-	Religious belief





332en02

## 2

# Art from Maurya to Gupta Period (4th C.B.C to 6th C.A.D)

## 2.0 INTRODUCTION

Chandragupta Maurya established an empire in India in the 4th C.B.C. For the first time, large portions of the subcontinent were unified politically. Chandragupta's grandson Ashoka was the most powerful and popular emperor of this dynasty. He was a great lover of art and architecture. Out of his contribution to art, few pillars or Sthambhas and sculptures remain. These are found throughout his vast empire, particularly in and around Magadha.

After the decline of the Maurya dynasty, the Sungas were the rulers of this empire. The Sunga and Satvahana period, that followed, contributed both in the field of Architecture and Sculpture. Most of these were related to Buddhism. The finest examples are the *Stupas* of Bharhut and Sanchi. The Kushanas arrived from the north western part of China and built an empire in the Northern part of India. Gandhara was the region situated on the western bank of the Indus river. The most important contribution of this school was the creation of the Buddha image. Buddha image appeared simultaneously in Gandhara and Mathura.

When the Gupta dynasty took over power from the Kusanas, it turned into a golden age for art and architecture. Artists of this age obtained great refinement in every form of art.

Few artworks have been selected for study to estimate the contribution of the Mauryas to the Guptas.

## 2.1 OBJECTIVES

After studying the lessons the learner will be able to:

- evaluate the artworks from Maurya to Gupta period;
- describe the size, style and place of these enlisted artworks;
- explain the characteristic features of these artworks;
- differentiate the evolution of style from period to period.



## 2.2 LION CAPITAL OF SARNATH

<i>Title</i>	–	<i>Lion Capital</i>
<i>Medium</i>	–	<i>Sand stone</i>
<i>Date</i>	–	<i>circa 3rd C.B.C</i>
<i>Finding site</i>	–	<i>Sarnath</i>
<i>Size</i>	–	<i>Height - 213.5 cm.</i>
<i>Artist</i>	–	<i>Unknown</i>
<i>Collection</i>	–	<i>Sarnath Site Museum</i>

### General Description

The sculpture of four lions grouped together, is the capital (Top part of a pillar) of the Sthambha of Sarnath's Deer park, which was created during the time of Ashoka. It is believed that it was at this site, Buddha preached his first sermon, thereby "turning the wheel of the law". It was excavated in 1905. The Chinese traveler Hsuan - Tsang mentioned of a seventy-foot high pillar with shining polish standing at the same site.

This composite sculpture shows a highly advanced form of art. This sculpture has been adopted as the emblem of Govt. of India

---

### INTEXT QUESTIONS (2.2)

---

Choose the right answer:-

- (a) Lion capital of Sarnath is made of
- (i) clay
  - (ii) marble
  - (iii) sand stone
- (b) The Sthambha was erected during the time of
- (i) Chandragupta
  - (ii) Asoka
  - (iii) Akbar
- (c) The sculpture has been adopted as the emblem of
- (i) Door darshan
  - (ii) Delhi Govt
  - (iii) Govt of India
-



*Chavri Beaver*

### 2.3 CHAURI BEARER

<i>Title</i>	-	<i>Chauri Bearer (yakshini)</i>
<i>Medium</i>	-	<i>Sand stone</i>
<i>Date</i>	-	<i>Circa 3rd C.B.C</i>
<i>Finding site</i>	-	<i>Didarganj, Patna</i>
<i>Size</i>	-	<i>Height 162.5 cm.</i>
<i>Artist</i>	-	<i>Unknown</i>
<i>Collection</i>	-	<i>Patna Museum, Patna</i>

#### General Description

Because of the technique, surface refinement and high polish, scholars think that the beautiful life-sized sculpture belongs to the Maurya phase. This female figure is also identified as a Yakshini and is often mentioned as the "Mona Lisa" of Indian Art. The figure is carved in the round with the perfect modeling of a female body.

There are very few sculptures in Indian art that surpass its beauty.

---

#### INTEXT QUESTION (2.3)

---

Fill up the blanks

- (a) The Chauri bearer was found at ".....".
  - (b) It belongs to Maurya period because it has ".....".
  - (c) The Chauri bearer is mentioned as the Indian ".....".
-

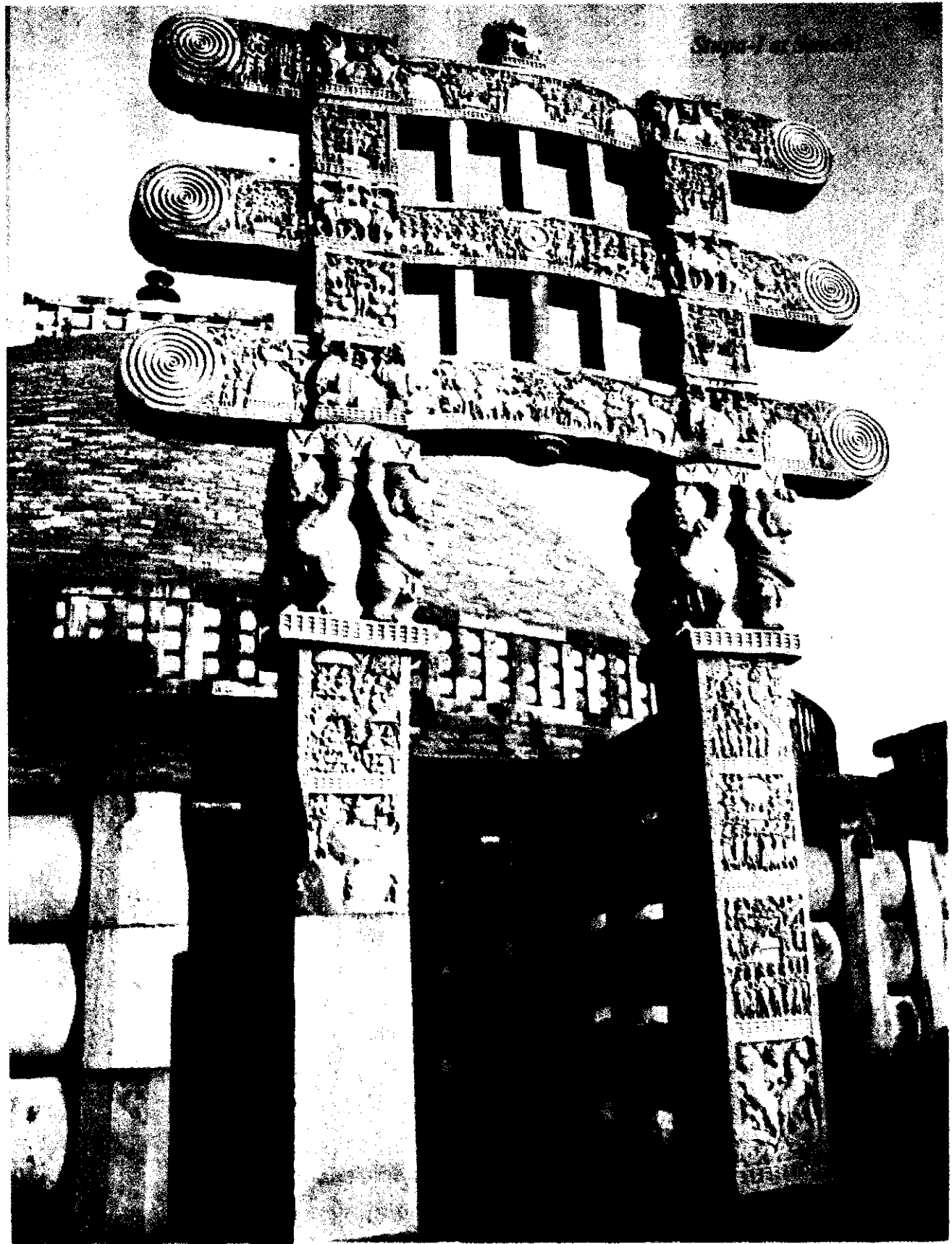

**2.4 STUPA -I AT SANCHI**

<i>Title</i>	–	<i>The great Stupa of Sanchi</i>
<i>Medium</i>	–	<i>Sand stone</i>
<i>Date</i>	–	<i>circa 3rd C.B.C through 1st C.A.D</i>
<i>Finding site</i>	–	<i>Sanchi, Madhya Pradesh</i>
<i>Size</i>	–	<i>Diameter - 36 meters</i>
<i>Artist</i>	–	<i>Unknown</i>

**General Description**

Stupa I is the largest Stupa at Sanchi. It is known as Mahastupa. It was built during the time of Asoka, and was enlarged to the present size by the Sungas. Probably a portion of the relics of Sakyamuni (Buddha) was kept inside the Stupa. During the second half of first century B.C. the Satavahanas erected the four beautifully carved toranas or Gateways.

**INTEXT QUESTIONS (2.4)**

Fill up the blanks

- The relics of ..... was kept inside the great Stupa.
- The largest Stupa of Sanchi is known as .....
- The four *Toranas* were erected by the ..... Dynasty.

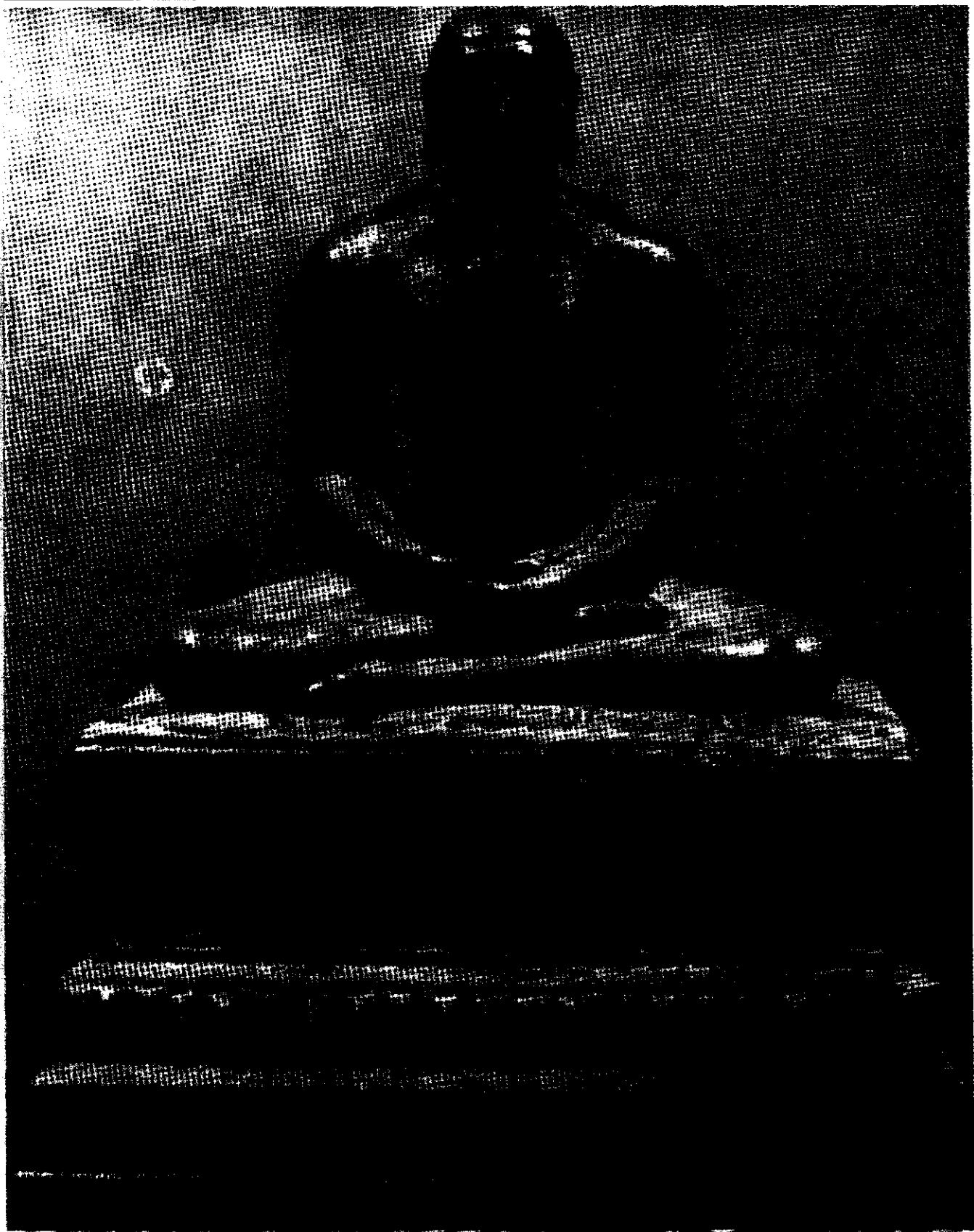

*Jain Tirthankar*



**2.5 JAIN TIRTHANKAR**

<i>Title</i>	–	<i>Jain Tirthankar</i>
<i>Date</i>	–	<i>Gupta period 5th C.A.D.</i>
<i>Finding site</i>	–	<i>Mathura</i>
<i>Size</i>	–	<i>95x60 cm</i>
<i>Artist</i>	–	<i>Unknown</i>
<i>Collection</i>	–	<i>State Museum, Lucknow, U.P.</i>

**General Description**

Many Jain images were found near Vidisa, which belonged to the early Gupta period. This image is of a Jain Tirthankar, seated on a square pedestal in *Vajraparyankasana mudra*. This image of Mahavira Swamy, the 24th Tirthankar, is made in the typical Buddhist and Jain style of the Kusana period.

In his teachings Mahavir Swamy laid emphasis on freeing the human being from the cycle of birth and death, which can be achieved by practicing Tri Ratna (three gems of action) like faith, righteous work and truthful words. The artist tried to express the Triratna in this image.

**INTEXT QUESTIONS (2.5)**

Choose the right answer

(a) The Jain Tirthankar Statue is now in

- (i) National Museum, N.Delhi
- (ii) Indian Museum, Kolkata
- (iii) State Museum, Lucknow

(b) The statue is in

- (i) Abhaya Mudra
- (ii) Bhumisparsha Mudra
- (iii) Vajraparyankasana Mudra

(c) The image is of

- (i) Buddha
- (ii) Mahavira
- (iii) Parsvanath.

*Seated Buddha*



## 2.6 SEATED BUDDHA

<i>Title</i>	-	<i>Sarnath Buddha</i>
<i>Medium</i>	-	<i>Buff Sand stone.</i>
<i>Date</i>	-	<i>Gupta period, 5 century A.D.</i>
<i>Finding Site</i>	-	<i>Sarnath, U.P.</i>
<i>Size</i>	-	<i>Height - 160 cm.</i>
<i>Artist</i>	-	<i>Unknown</i>
<i>Collection</i>	-	<i>Sarnath Site Museum, Sarnath</i>

### General Description

The beautiful figure is seated in Padmasana, with upturned soles. His hands are held in Dharmachakramudra. The ear lobes are long and the eyes are half-closed. The face is calm and has a spiritual expression. Behind the head is a huge halo covered with a beautiful floral decoration.

This sculpture is one of the best examples of Gupta art. The matured simplicity and rational use of ornamentation prove the greatness of the artist.

---

### INTEXT QUESTIONS (2.6)

---

Fill up the blanks -

- (a) The beautiful figure is seated in ..... Pose.
  - (b) Sarnath Buddha belongs ..... Period.
  - (c) Hands of Sarnath Buddha are held in ..... Mudra.
-

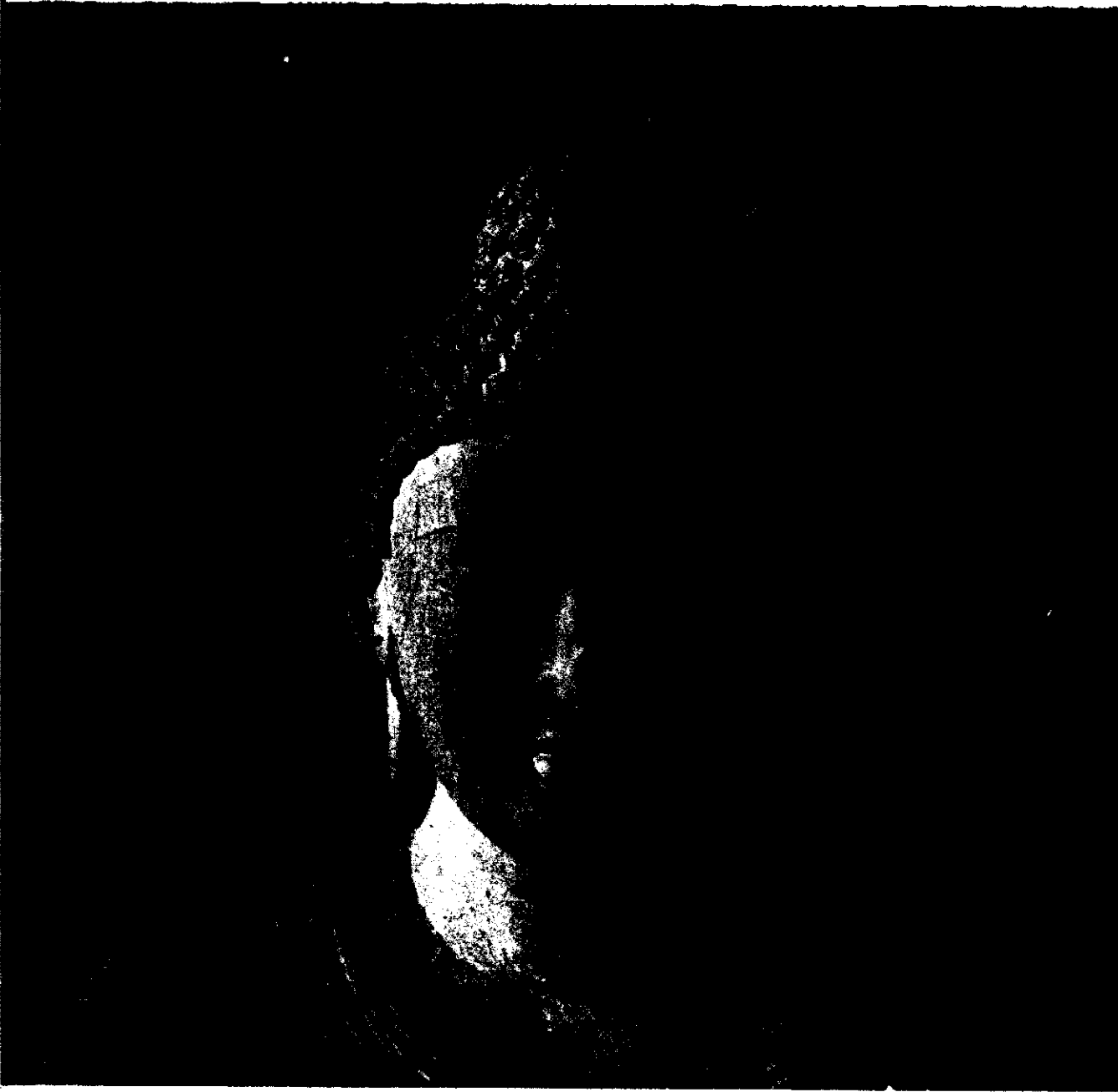

*Seated Buddha (Gandhara Style)*

## 2.7 SEATED BUDDHA (GANDHARA STYLE)

<i>Title</i>	-	<i>Seated Buddha</i>
<i>Medium</i>	-	<i>Red Sand Stone</i>
<i>Date</i>	-	<i>Kusana period</i>
<i>Finding site</i>	-	<i>Katra-Tila, Mathura, U.P.</i>
<i>Size</i>	-	<i>Height - 75 cm.</i>
<i>Artist</i>	-	<i>Unknown</i>
<i>Collection</i>	-	<i>Government Museum, Mathura, U.P.</i>

### General description

Gandhara is the old name of the territory on the western bank of the Indus river. The early school flourished during the first and second century A.D. came to its maturity during the time of the Kusanas. These sculptures were found from Taxila in the west to Samath in the east. The most important contribution of the Gandhara school was the creation of the Buddha image. This image shows realistic rendering of drapery and a tuft-like hair style on top of the head. One arm of this statue is missing, which probably was in *Abhaya Mudra*.

### INTEXT QUESTIONS (2.7)

Fill up the blanks

- The seated Buddha belongs to the ..... style.
- This statue is made of ..... stone.
- The most important contribution of Gandhara school was the creation of ..... image.

### 2.8 SUMMARY

The contribution of the period from 4th C.B.C to 6th C.A.D towards art and culture of India is most important. The art and culture of this period was influenced by varied religious beliefs like Hindu, Jain and Buddhist. All these religions were patronized by the ruler of different faiths and they were treated equally. Though Buddhists art spread all over India, the other religious arts also flourished in the same way. Buddha images were made for the first time by Gandhara and Mathura artists. Stupas were built with equal enthusiasm both in the Northern and Southern parts of India.

---

## 2.9 ANSWERS OF INTEXT QUESTIONS

---

- |     |                        |     |                              |
|-----|------------------------|-----|------------------------------|
| 2.2 | (a) Sand stone         | 2.3 | (a) Didarganj                |
|     | (b) Ashoka             |     | (b) High polish              |
|     | (c) Govt. of India     |     | (c) Mona-Lisa                |
| 2.4 | (a) Sakyamuni          | 2.5 | (a) State museum of Lucknow  |
|     | (b) Mahastupa          |     | (b) Vajra Paryankasana Mudra |
|     | (c) Satavahanas.       |     | (c) Mahavira                 |
| 2.6 | (a) Padmasana          | 2.7 | (a) Gandhara style           |
|     | (b) Gupta period       |     | (b) Red sand stone           |
|     | (c) Dharmachakra mudra |     | (c) Buddha                   |

---

## 2.10 MODEL QUESTIONS

---

1. What are the major contributions of the Mauryan to Buddhist art?
  2. Discuss the style of Gandhara Buddhist sculpture.
  3. Write the main features of the statue of Jain Tirthankara.
- 

## 2.11 GLOSSARY

Hsuan Tsang	-	Chinese traveller
Composite Sculpture	-	combined forms in one sculpture
Emblem	-	symbol of a state
Mona Lisa	-	Famous painting of Leonardo-da-Vinci
Modeling	-	brings illusion of volume
Relics	-	remains of a deceased person.
Tirthankar	-	One who has attained perfect knowledge
Mudra	-	Symbolic hand gesture
Spiritual	-	conscious thought and emotion
Drapery	-	clothes with folds
Tuft	-	bunch or cluster



332en03

## 3

# Ajanta Caves

### 3.0 INTRODUCTION

Ajanta was a Buddhist settlement situated near Aurangabad in Maharashtra. It was discovered by some British soldiers. Some 29 caves have been cut from a horseshoe-shaped hillside. Paintings have been found in six of these caves. These caves are of two types viz. Chaityas and Viharas. Chaitya was a place for worship while the Vihara was the dwelling-place of the monks. The walls, ceiling and the front part of the Chaityas and Viharas are beautifully decorated with sculpture and painting. The themes of these art-works are based on Buddhist scriptures, and mainly the stories of Jataka.

The technical methods of Ajanta paintings is tempera. A rough mud Plaster, containing cowdung and animal hair was first pressed on the rocks. A coat of fine lime plaster was laid over it. The colour was applied after the ground was completely dry.

### 3.1 OBJECTIVES

After studying the lesson the learner will be able to:

- describe the arts of Ajanta caves;
- state the title of the enlisted wall paintings of Ajanta;
- explain the technique, method, size and style of these paintings;
- describe the characteristic features of Ajanta cave paintings.



*Padmavati: Bodhisattva*



### 3.2 PADMAPANI BODHISATTVA

<i>Title</i>	-	<i>Padmapani Bodhisatva</i>
<i>Medium</i>	-	<i>Tempera on wall</i>
<i>Date</i>	-	<i>Late 5th C.A.D.</i>
<i>Finding site</i>	-	<i>Ajanta cave No 1</i>
<i>Size</i>	-	<i>5' 9½"</i>
<i>Artist</i>	-	<i>Unknown</i>
<i>Place</i>	-	<i>Ajanta, Aurangabad, Maharashtra</i>

#### General Description

This painting is considered to be a masterpiece of Indian art. The slightly inclined posture gives the suggestion of grace. The elegant features of the face and downcast eyes give an impression of serene meditation and compassion. The ornamentation is very rationally done. He wears a pearl and sapphire necklace. He is holding a blue lotus in his right hand. The size of the figure is quite large.

#### INTEXT QUESTIONS (3.2)

Fill in the blanks

- It is called Padmapani because the figure is holding a .....
- The medium of this painting is .....
- It is found in cave no ..... of .....



*Mara Vajra*

### 3.3 MARA-VIJAY

<i>Title</i>	-	<i>Mara-Vijaya</i>
<i>Medium</i>	-	<i>Tempra on wall</i>
<i>Date</i>	-	<i>Gupta Vakataka 5th-6th century</i>
<i>Finding site</i>	-	<i>Ajanta cave No 1</i>
<i>Size</i>	-	<i>12' X 8'</i>
<i>Artist</i>	-	<i>Unknown</i>
<i>Place</i>	-	<i>Aurangabad, Maharashtra</i>

#### General Description

Theme of Mara-Vijaya narrates the story of the conquest on all the vices and temptation of the material world by Buddha during his meditation. In this painting, the defeat of the young women is shown, who tried to disturb the concentration of Buddha. The female figures are depicted in different postures and gestures of frustration and guilt feelings. The Ajanta painters were masters in portraying feminine emotions and elegance.

---

#### INTEXT QUESTIONS (3.3)

---

Choose the right answer

(a) The story of conquering temptation by Buddha is known as -

- (i) DigVijaya
- (ii) Tapasya
- (iii) Mara-Vijay

(b) The Mara Vijaya Painting is found in

- (i) Ajanta cave No 1
- (ii) Ajanta cave No 2
- (iii) Ajanta cave No 3

(c) Size of this painting is

- (1) 12'X20'
  - (2) 10'X10'
  - (3) 12'X8'
-

### 3.4 SUMMARY

Almost all the caves of Ajanta belong to the Vakataka period. The paintings in cave No 1 are of later date than cave No.9 and 10. Though the subjects of these paintings are religious, there is a keen interest in the common world. The main aim was to teach the basic principles of Buddhism through Jataka Stories.

Ajanta painters followed the traditional method of Indian wall painting. The principle colour in use were red, yellow, blue, white and green. All the colours were locally available. These paintings are basically linear, though the painters were masters in handling colour.

---

### 3.5 ANSWERS OF INTEXT QUESTION

---

3.2 (a) blue lotus (b) Tempera on wall (c) Cave no 1, Ajanta

3.3 (a) Mara Vijaya (b) Ajanta cave (c) 12'X8'

---

### 3.6 MODEL QUESTIONS

---

1. What do you know about Ajanta caves?
  2. Write a short note on the techniques of Ajanta paintings.
  3. Briefly assess the artistic achievements of Ajanta painters.
- 

### 3.7 GLOSSARY

Scriptures	-	religious writings.
Tempera	-	painting with pigments mixed with egg or other binder.
Sapphire	-	Blue gem.
Vakataka	-	A dynasty that ruled almost same times of the Guptas.
Jataka	-	Stories of Buddha's previous birth in different forms like animal, bird, plants etc.



# Temple Art and Sculpture

## 4.0 INTRODUCTION

Indian sculpture was mostly meant for temple ornamentation in the ancient and medieval period. The regular building of structural temples in bricks and dressed stone began in the Gupta age, although there is some evidence of small shrines before the Guptas. During the 8th C.A.D there was prolific building activities throughout India. The Palas in the east, Cholas and Pallavas in the South, Rastrakutas and Chandellas in the central part of India, built beautiful temples, embellished with sculpture from 8th to 10th C.A.D. The tradition of temple sculpture flourished even after that in some areas like Vijaynagar, Mysore, Rajasthan, Bengal and Orissa till 12th C.A.D.

An introduction will be given to some selected temple sculptures in this lesson.

The following are the enlisted artworks in some famous temples of India.

- (a) Trimurti at Elephanta (Near Mumbai)
- (b) Mahisasura Mardini at Ellora (Maharashtra)
- (c) Kandariya Mahadeva temple at Khajuraho (Madhya Pradesh)

## 4.1 OBJECTIVES:

After studying this lesson the learner will be able to:-

- (a) explain in brief the enlisted temples and sculptures;
- (b) state the name of enlisted temples and sculptures;
- (c) mention pattern, materials, architect, period, site and style of these temple sculptures;
- (d) identify the period of enlisted sculptures;
- (e) tell the main characteristics of enlisted temples.



*Mahishasurmardini*

## Sculpture of Devi at Ellora

## 4.2 MAHISHASURMARDINI

<i>Title</i>	<i>Mahishasurmardini</i>
<i>Place</i>	<i>Kailash Temple, Ellora, Maharashtra</i>
<i>Period</i>	<i>8th century A.D.</i>
<i>Medium</i>	<i>Rock-cut</i>
<i>Style</i>	<i>Rastrakuta</i>

The sculpture is of Devi Durga slaying Mahisasura, the buffalo demon. The 8th century Hindu rock-cut Kailash temple of Ellora in Western India is a remarkable piece of work. This sculpture adorns wall of the Kailash temple which was dedicated to the worshipers of Shiva. This relief panel treats battle scenes in which the deity is engaged in destroying the demon. The sculpture, particularly the scene depicting Devi's great battle, represents a high point in the development of Hindu iconography. Its treatment in narrative sculpture as well as human figure is commendable. This composition is one of the most dramatic treatments in the history of Indian monumental sculpture. The theme of Durga destroying the buffalo demon or Mahishasura Mardini is very popular in sculpture of India. Finally it is the combination of grace, beauty and power of expression, and dramatic composition that makes the Durga of Ellora a remarkable relief sculpture.

### INTEXT QUESTIONS. (4.2)

Fill up the blanks

- The Mahisasura Mardini sculpture shows Devi Durga slaying \_\_\_\_\_.
- This sculpture is in \_\_\_\_\_.
- This belong to the \_\_\_\_\_ style of \_\_\_\_\_ A.D.



*Trimurti*



**4.3 TRIMURTI**

<i>Title</i> -	<i>Trimurti (Three headed Mahesha)</i>
<i>Medium</i> -	<i>Rock cut</i>
<i>Size</i> -	<i>5.20 meters Height</i>
<i>Period</i> -	<i>8th Century AD.</i>
<i>Place</i> -	<i>Elephanta Mumbai, Maharastra</i>

The Mahesha or Shiva Trimurti is a dramatic representation of the supreme form of Shiva as the central face, Shiva as a destroyer is on the left and on the right is the gracious feminine deity. The Gods who were most commonly represented in Hindu pantheon were Shiva, the destroyer and Vishnu, the preserver while the third great God of the Hindu trinity was Brahma the creator. One of the most powerful rendering of this multiple nature of the deity is seen at Elephanta, where Shiva is seen as the three headed Mahadeva. The heads represent three different aspects of the God, the center one is his creative self or Sadasiva, the left his destructive nature or aghora and the right is the gracious feminine manifestation of the beauty of nature or Vamadeva.

**INTEXT QUESTIONS (4.3)**

Choose the right answer

- (a) The statue of Mahesha is of  
 (i) Bramha            (ii) Krisna            (iii) Shiva
- (b) The central head of the Trimurti represents  
 (i) Rudra            (ii) Nataraja            (iii) Sadasiva
- (c) The destructive aspect of Mahesha murti in the left head is called  
 (i) Aghora            (ii) Varnadeva            (iii) Mahadeva.

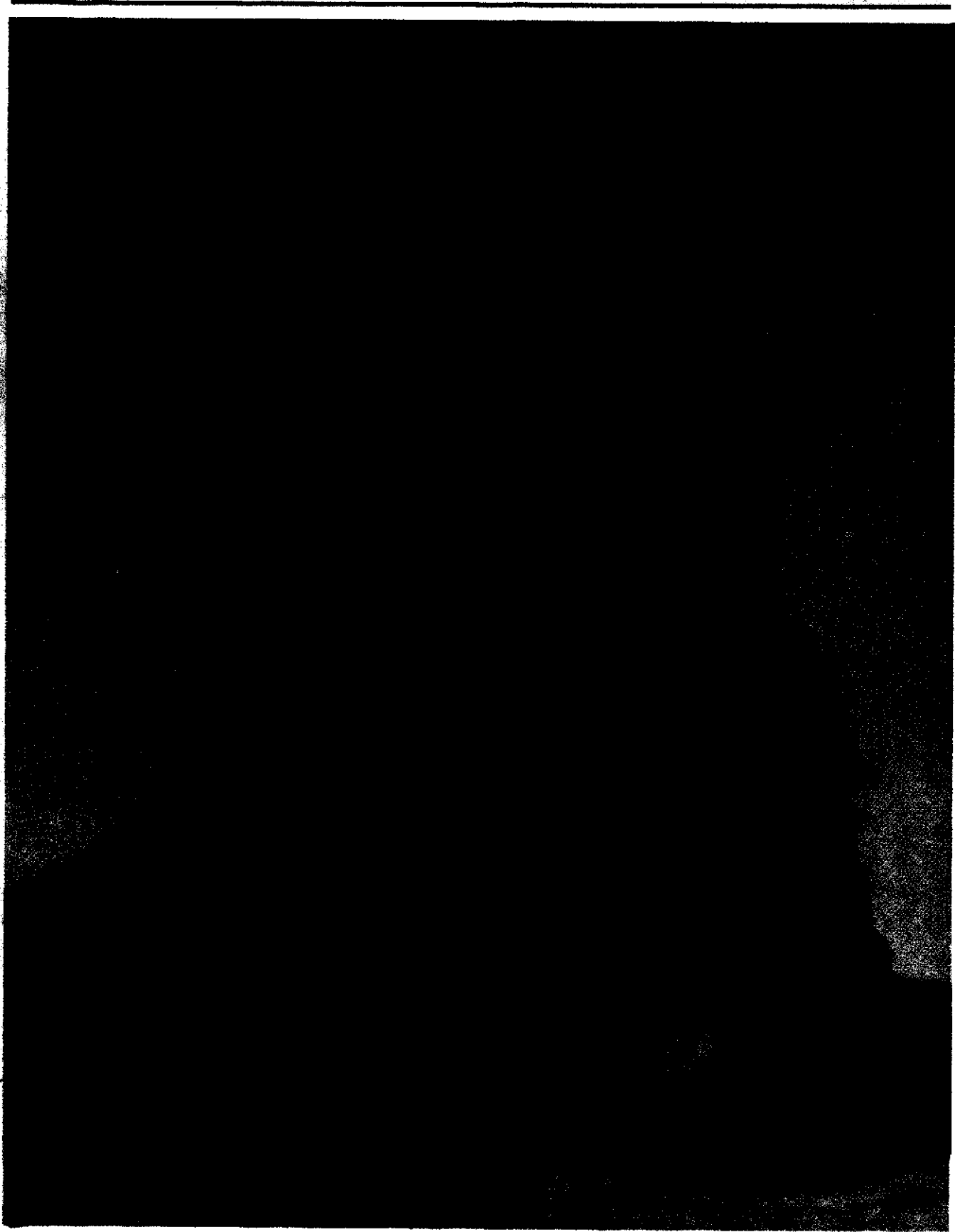

#### 4.4 KANDARIYA MAHADEV TEMPLE

<i>Title</i>	-	<i>Kandariya Mahadev Temple</i>
<i>Period</i>	-	<i>Chandella dynasty, 10th century A.D.</i>
<i>Height</i>	-	<i>Height 101.9"</i>
<i>Material</i>	-	<i>Sandstone</i>
<i>Place</i>	-	<i>Khajuraho, Madhya Pradesh</i>

The Kandariya Mahadev Temple is the most magnificent and the biggest temple of the Khajuraho school of architecture. It is a temple of perfect proportions and rich ornamentation. It is one of the finest achievements of Indian temple architecture in Vesara style. The temple was built of sand stone.

There are three bands of sculptures on the Jangha of the temple. There are quite a number of erotic figures, along with usual sculptures of Hindu pantheon, all carved to perfection.

The base of the temple is filled with diverse sculptures. Inside the temple it is plain and dark, where one can meditate peacefully.

---

#### INTEXT QUESTIONS (4.4)

---

Fill up the blanks

1. It is one of the finest achievements of Indian temple architecture in the \_\_\_\_\_ style.
2. There are three \_\_\_\_\_ of sculpture on the \_\_\_\_\_ of the temple.
3. Inside of the temple is \_\_\_\_\_ and \_\_\_\_\_.

---

#### 4.5 SUMMARY

In the post Gupta period it is almost impossible to consider sculpture apart from architecture, it is so much a part of the temples which it serve to decorate. All the three distinct architectural styles of temples, Viz, Nagara (of the North) Dravida (of the South) and Vesara (of the central) are treasures of Indian Sculpture. The temple sculpture of India is to be found all over India in various styles and forms.

---

#### 4.6 MODEL QUESTIONS

---

1. What are the characteristics of Mahishasurmardini at Kailash temple of Ellora.
2. Write in brief the main features of Trimurti at Elephanta near Mumbai.
3. Why is the Kandariya Mahadeva Temple at Khajuraho in Madhya Pradesh famous?

---

#### 4.7 ANSWER OF INEXT QUESTIONS.

---

- 4.2 (a) Buffalo demon (b) Ellora (iii) Rastrakuta, 8th century  
4.3 (a) (iii) Shiva (b) (iii) Sadasiva (c) Aghora.  
4.4 (i) Vesara, (b) Bands, Jangha, (c) Plain, Dark

#### 4.8 TERMINOLOGY

ashrama:	monastic retreat
apsars:	celestial dancing girls
avatar:	incarnation
bhakti:	reverance
bahmin:	priestly caste
caitya:	place of worship of the Buddishts
cakra:	Wheel
dharma:	law, doctrine, righteousness
Garbha Griha:	literally 'womb chamber', inner sanctum of temple
Gopuram:	Gate house of temple Dravide temple
Kalasha:	Water pitcher, vase
Kumbha:	bulbous water pot
Linga:	phallus, most common symbol of Shiva
Mandapa:	hall or pillared pavilion
Puja:	worship
Ratha:	temple chariot
Sabha:	assembly
Stupa:	memorial of Buddhist saint
Tirth:	place of spiritual regeneration
Vastu:	residence,
Vihara:	residential quarter of monastery
Yoni:	female reproductive organ.



## Indian Bronzes (Sculpture)

### 5.0 INTRODUCTION

From earliest times to Modern period, the Dancing Girl is the earliest example of metal sculpture. The most outstanding are the bronze images particularly popular in Southern India. Beginning of the seventh century, a school of metal sculpture was evolved in South-India. The Chola dynasty of 10th C. produced some of the greatest works of Hindu Sculptures in the Southern part of India. The "Lost-wax" process (cire perdue) was used. The sculptures are not only technically superb but they are aesthetically outstanding.

### 5.1 OBJECTIVES

After studying this lesson, the learner should be able to :

- explain in brief the process to make bronze sculpture;
- state the names of the famous bronze sculptures found in India;
- identify the period of the bronze sculptures;
- tell about the materials used for making bronze sculptures;



*Cosmic Dance of Lord Shiva*

## 5.2 COSMIC DANCE OF LORD SHIVA

<i>Title</i>	-	<i>Nataraja</i>
<i>Period</i>	-	<i>Chola 11<sup>th</sup> century A.D.</i>
<i>Medium</i>	-	<i>Bronze</i>
<i>Size</i>	-	<i>Height 98X84 cm</i>
<i>Site</i>	-	<i>Thanjavour, Tamilnadu</i>
<i>Style</i>	-	<i>Chola</i>
<i>Collection</i>	-	<i>National Museum, New Delhi.</i>

### General Description

Among the numerous Gods represented in the bronze images, the most popular was Shiva. He is engaged in the dance of the universe and is trampling on the dwarf of illusion. He is holding the drum of creation in the right hand and the fire of destruction in the corresponding left. The lower right hand is stretched out in a gesture of protection (*abhaya*) and the lower left signifies salvation. This sculpture is remarkable for the balance of the limbs and the rhythm running through them. The cosmic dance represents the essence of the Hindu concept of life. The dynamic movement of the God expresses the eternal process of creation, destruction, and re-creation.

### IN-TEXT QUESTIONS (5.2)

Fill in the blanks

1. 'Nataraja' collection at the National Museum, New Delhi is made of \_\_\_\_\_.
2. Nataraja is holding the \_\_\_\_\_ of creation in the upper hand and \_\_\_\_\_ of destruction in the left.
3. Bronze casting of Nataraja is belongs to the \_\_\_\_\_ dynasty.



*Dokra casting (Tribal Bronze casting)*



**5.3 DOKRA CASTING (Tribal Bronze casting)**

<i>Title</i>	-	<i>Hourse Riding</i>
<i>Medium</i>	-	<i>Bronze, Brass</i>
<i>Artist</i>	-	<i>Tribals</i>
<i>Place</i>	-	<i>Madhya Pradesh, Tikamgarh</i>

**General Description**

Dokra casting or the lost-wax (Cire-Perdue) technique is one of the oldest metallurgical art forms used in ancient civilizations in India and also in China, Greece and Mesopotamia. The tribals are still using this process.

It involves the following steps.

1. Making a clay cover by firing in kiln.
2. Wrapping bee-wax around the core to get a replica.
3. Coating the replica with wet clay and then drying in the sun.
4. Heating should melt the wax which flows out early.
5. Filling with metal. Cast in furnace and left to cast.
6. Breaking the mould to get a Dokra Artifact.

**IN-TEXT QUESTIONS (5.3)**

Put (✓) or (x)

1. Dokra casting is the lost-wax technique.
2. The technique of Dokra casting is one of the oldest metallurgical art form.
3. Coating the replica with Dry clay.

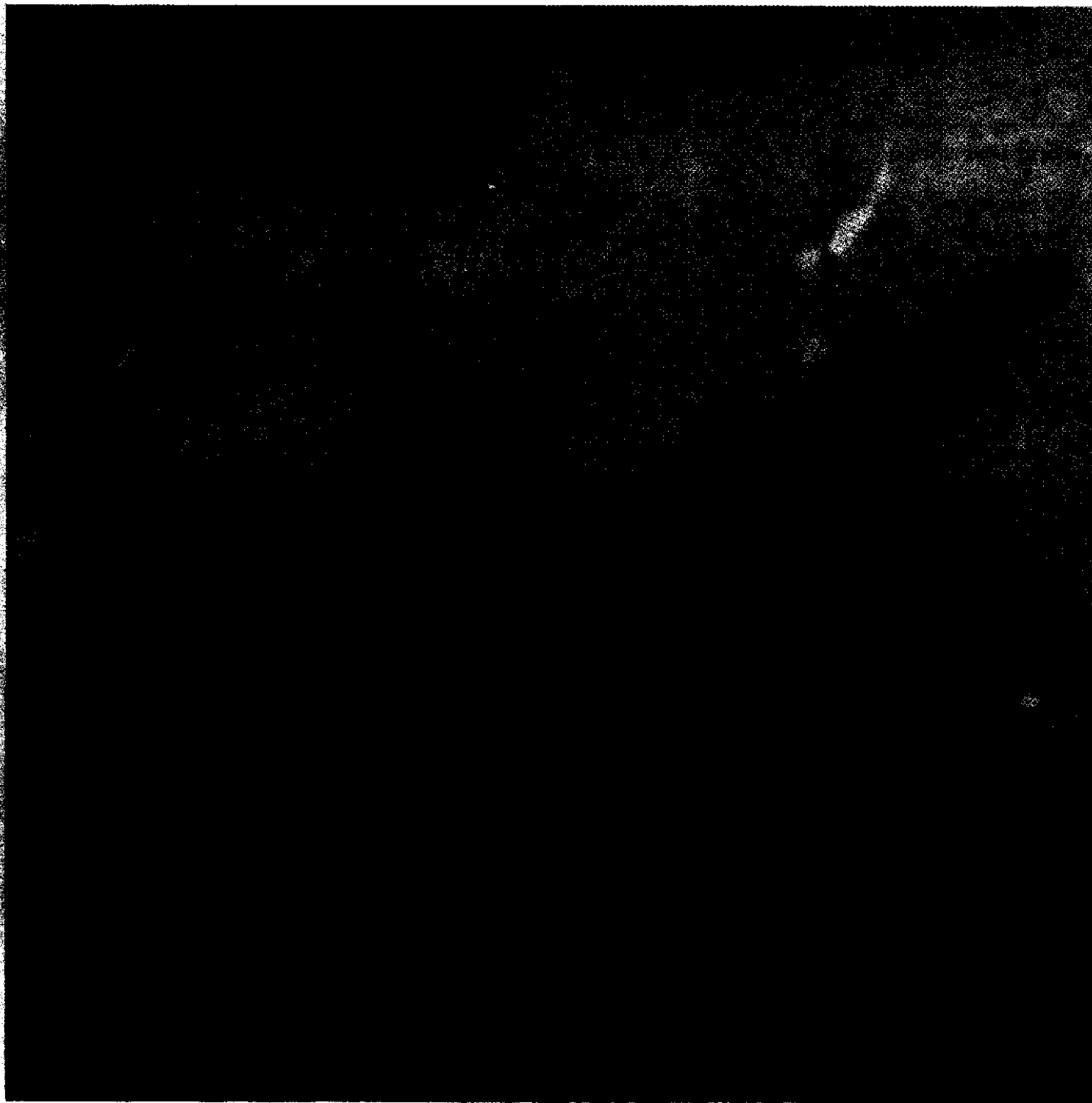

*Triumph of Labour*

## 5.4 TRIUMPH OF LABOUR

<i>Title</i>	-	<i>Triumph of Labour</i>
<i>Artist</i>	-	<i>Shri Devi Prasad Roy Chowdhury</i>
<i>Medium</i>	-	<i>Bronze</i>
<i>Date</i>	-	<i>1954</i>
<i>Collection</i>	-	<i>National Gallery of Modern Art, Jaipur House, New Delhi.</i>

### General Description

Shri D.P. Roy Chowdhury was one of the most outstanding artists in the Indian art scene. He was primarily a sculptor and a painter. He was also proficient in wrestling, hunting, writing and music. He was not in favour of holding exhibitions. He said, "I consider my modest studio as a sort of old, sacred temple devoted to the cause of art. I worship the object I create. I can never think of them being carried now and then for public view. Those who are real lovers of art are welcome to my studio". He went to Abanindranath Tagore as his disciples in his teenage and followed the master's style and technique. He is known and respected today more as a sculptor. In his early life he worked under the noted sculptor *Hiranmoy Roy Chowdhury*.

As a composition *The Triumph of Labour* is a master piece. This will remain as an outstanding example of contemporary Indian sculpture. The four figures in the first group are perfect anatomical studies of men engaged in a formidable task of lifting a huge block. The most distinctive feature of this group is its universal appeal and rare quality of mobility. This sculpture symbolically represent the sacrifice, which Indians made for winning Independence.

---

### TEXT QUESTION (5.4)

---

Fill in the blanks:-

D.P. Roy Chowdhury was proficient in \_\_\_\_\_, \_\_\_\_\_,  
and \_\_\_\_\_.

In his early life Shri D.P. Roy Chowdhury started work under the noted sculptor \_\_\_\_\_.

The Triumph of Labour is a symbol of "\_\_\_\_\_".

---

## 5.5 SUMMARY

The remarkable collection of bronze sculpture at the Government museum, Chennai, is the Nataraja, Cosmic dance of Lord Shiva. The Triumph of Labour installed at National Gallery of Modern Art and the Martyr's Memorial installed at Teen Murti Marg, New Delhi, are outstanding examples of Modern bronze sculpture. The process of preparing bronze sculpture is known as cire-perdue meaning lost wax process. Dokra Art and bronze casting are done by the same process.

---

## 5.6 MODEL QUESTIONS

---

1. What are the characteristics of Nataraja bronze sculpture?
2. Write the method of preparing the lost wax process.
3. Name the dynasty under which Bronze sculpture reached its Zenith.

---

## 5.7 ANSWERS OF INTEXT QUESTIONS.

---

5.2 1. bronze 2. drum, fire 3. chola

5.3 1. ✓ 2. ✓ 3. ✓

5.4 1. Hunting, Writing, Music 2. Hiranmoy Roy Chowdhury  
3. Sacrifice

## 5.8 TERMINOLOGY

**Wrestler:** - A sport one tries to throw a person to the ground without hitting him.

**Exhibition:-** To organize a show.

**Martyr's Memorial:-** Remembering the dead heroes

**Formidable:-** Very difficult.

**Chola dynasty:-** Period of 11th century AD.

**Dwarf:-** A person much shorter than normal height

**Drum:-** Musical instrument of Lord Shiva.

**Dynamic movement:-** Forceful movement.

**Disciple:-** One who learns from another

**Technique:-** Method of doing by mechanical skill.

**Universal appeal:-** Affecting all

**Tramples to -** Crush under the feet



# Indo-Islamic Architecture

## 6.0 INTRODUCTION

During 8th century A.D. Turkish, Arabian and Mongolian cultures started invading into the main cultural stream of India. When these foreign cultural people started living in India during medieval period, they employed local Hindu masons for constructing their architectural marvels i.e. mosques, palaces, tombs, *maqbaras*, *madarsas* and forts/fortresses. It is because of this reason that we see the mixture of various cultural influences in these architectural works of medieval India. Thus a new Indianised style of semi-circular domes, mehrabs (conical minars which were earlier being used for temple niche of the Buddhists or Hindu deities) came into existence. Squirish forms of columns, mosques without minars, small arched niche (semi-circular) conical columns, are some of the other examples of the mixture of cultural style.

In this lesson, examples of only three following monuments of medieval India have been taken up in which all the qualities of the mixture of various cultural influences in the art of Indo-Islamic Architecture are well established.

## 6.1 OBJECTIVES

After studying this lesson, the learner should be able to :

- tell the names of the enlisted monuments;
- describe general introduction of the given monuments;
- differentiate the stylistic differentiation of architecture of enlisted monuments;
- explain construction materials, its place, style, and qualities of architecture of a given monument;
- identify the main features of Indo-Islamic Architecture.

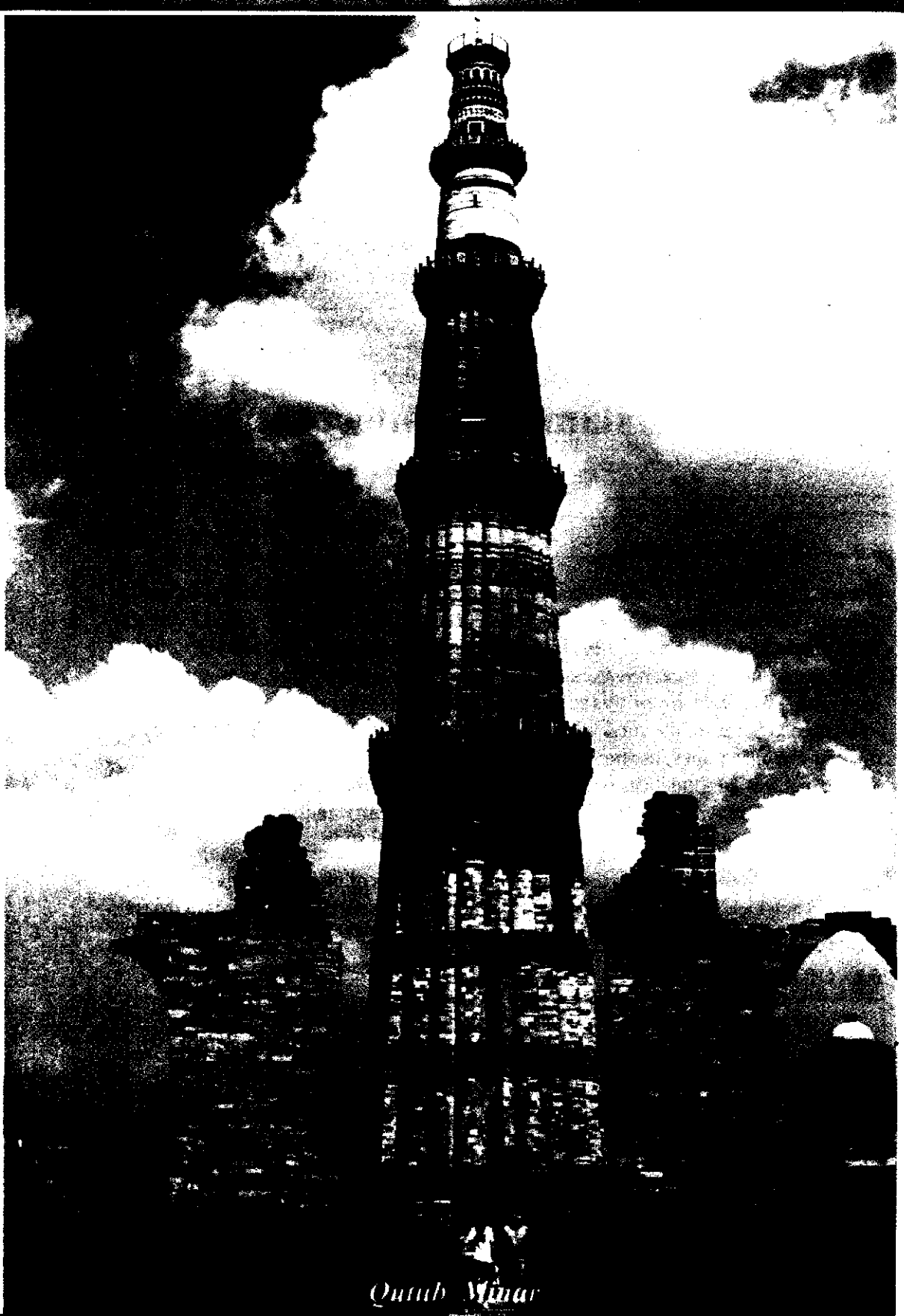

*Qutub Minar*

## 6.2 QUTUB MINAR

<i>Title</i>	-	<i>Qutub Minar</i>
<i>Medium</i>	-	<i>Red and White Sand stone</i>
<i>Date</i>	-	<i>1206 to 1232 A.D.</i>
<i>Site</i>	-	<i>Delhi</i>
<i>Size</i>	-	<i>Height - 72.56 meters</i>

### General Description

Qutub-ud-din Aibek, the first of the slave Dynasty ruler, first of all started getting this *minar* constructed as a 'symbol of Victory' but later he sponsored it to his Dilli (Delhi) master Sufi Saint - Bakhtiyar Kaki as a gift. This *minar* is known as '**Qutub-minar**'. This *minar* is a good example of Indo-Turkish style of Architecture. Its boldly projected balconies on each storey, carved arabic scriptures on stones (they are mostly inscriptions from Quran and titles of the Emperor) and rope-winding stair-cases are its special features. This is the highest *minar* of India measuring **71.3 meters high**.

Red and white sand-stones are used in constructing the Qutub-minar. On its top floor marble stones are also used. Stucco lime-mixture as mortar for cementing its constructional work has been used.

Qutub-ud-din Aibek could get only its first storey constructed during his rein - 1206 to 1210 AD; Afterward king Iltutmish got the 2nd, 3rd and 4th storeys completed. But at the end (though badly conceived) 5th storey was constructed by Emperor Firozeshah Tughluk of Tughluk dynasty.

Qutub-minar is situated at Mehrauli in Delhi

### Style of Architecture

Qutub-minar is most famous for its '*Shankh*' like form;

its strong ribs supporting its balconies; geometrical decorative carvings and arabic inscriptions along with pure Indian decorative symbols in its stylistic construction.

### INTEXT QUESTIONS (6.2)

Tick mark (✓) the right answer

- (a) Qutub Minar was built as a symbol of
- Victory
  - Love
  - Religion
- (b) Top floor of Qutub Minar is built of
- Sand stone
  - Marble
  - Bricks
- (c) This Minar is good example of
- Mughal architecture
  - Hindu architecture
  - Indo-Turkish architecture

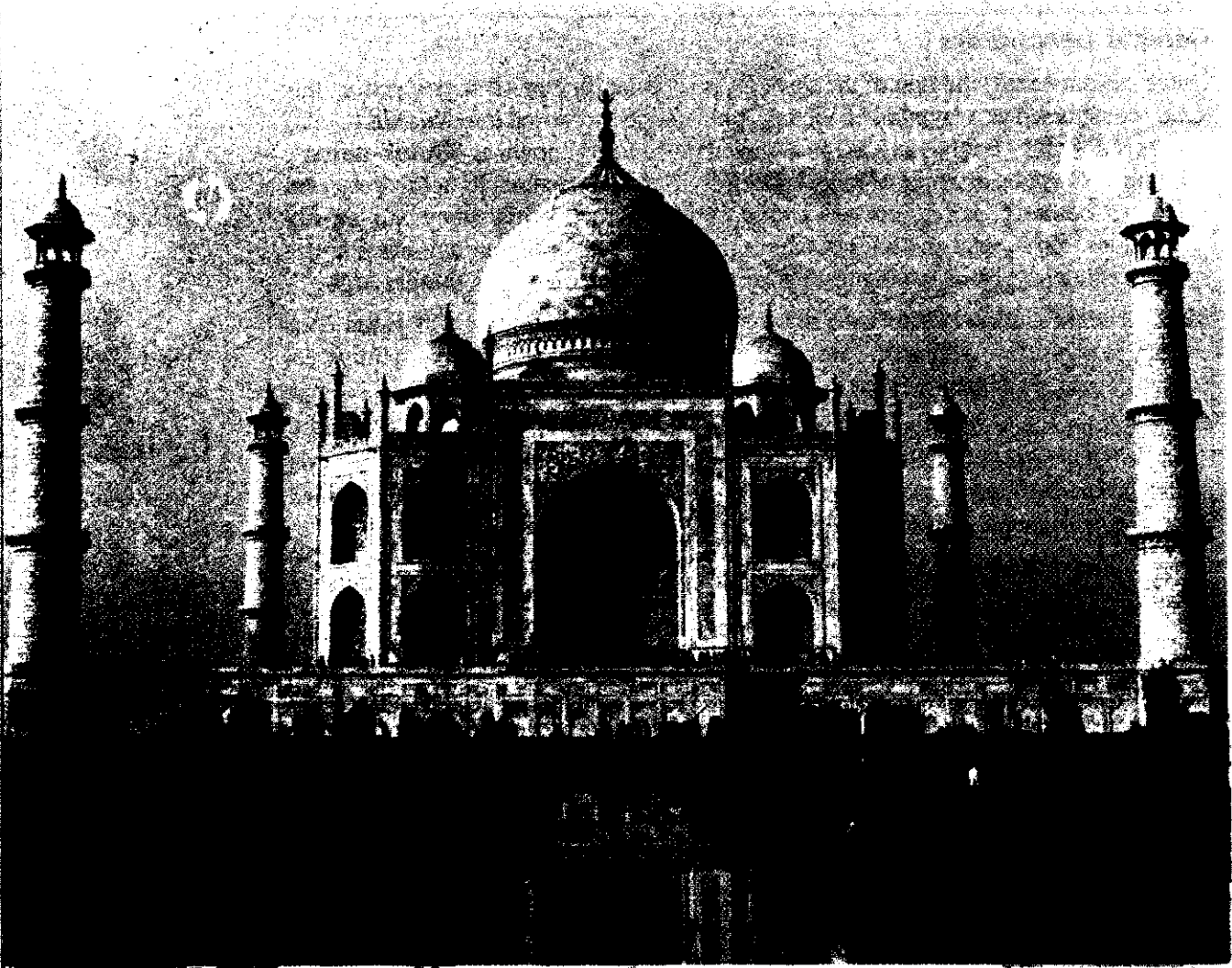

***Taj Mahal***



### 6.3 TAJ MAHAL

<i>Title</i>	-	<i>Taj Mahal</i>
<i>Medium</i>	-	<i>White marble stone</i>
<i>Date</i>	-	<i>1632 to 1654 AD</i>
<i>Site</i>	-	<i>Agra</i>
<i>Size</i>	-	<i>Groundplan 580 meters X 305 meters, Height - 187</i>

#### General Description

Mughal Emperor Shah Jahan is a well known figure until today for its building construction activities especially for Taj Mahal. He got Taj Mahal constructed as a memorial for his beloved wife Mumtaz Mahal. In this building there are two tombs (graves) - one of his wife Mumtaz and the other of his own. In fact such memorial buildings constructed over the tombs are called 'Maqbaras'. Construction of Taj Mahal is a fine blend of Indian and foreign styles of architectural art.

White marble stone from Makrana mines in Rajasthan was brought for the construction of Taj Mahal, and lime stucco was used as mortar for cementing its constructional work.

Shah Jahan ruled from 1628 to 1658 A.D. and during this period he spent twenty two years for the construction of Taj Mahal. This beautiful building is situated on the bank of Yamuna river in the city of Agra. The area of the main building is 313 square feet. The highest dome of the building is 186 feet high.

At the four corners of the building there are four *minars* each having 163 ft. height. The double layered domes and minarets are constructed in Iranian style, but its arches and balconies are in Persian style. The main emphasis of this building has been especially laid on the layout, proportions of its different parts and on the beautiful arabic inscriptions. Geometrical decorative motifs and some other constructional aspects like cubical brackets, designing of the basements and the high level of platform are some of the best representations of Indian style of architecture.

---

#### INTEXT QUESTIONS (6.3)

---

Fill up the blanks

- (a) Shah Jahan built Taj Mahal as a \_\_\_\_\_ of his wife \_\_\_\_\_.
- (b) Taj Mahal is situated on the bank of \_\_\_\_\_, in the city of \_\_\_\_\_.
- (c) Taj Mahal is built of \_\_\_\_\_ stone.
-

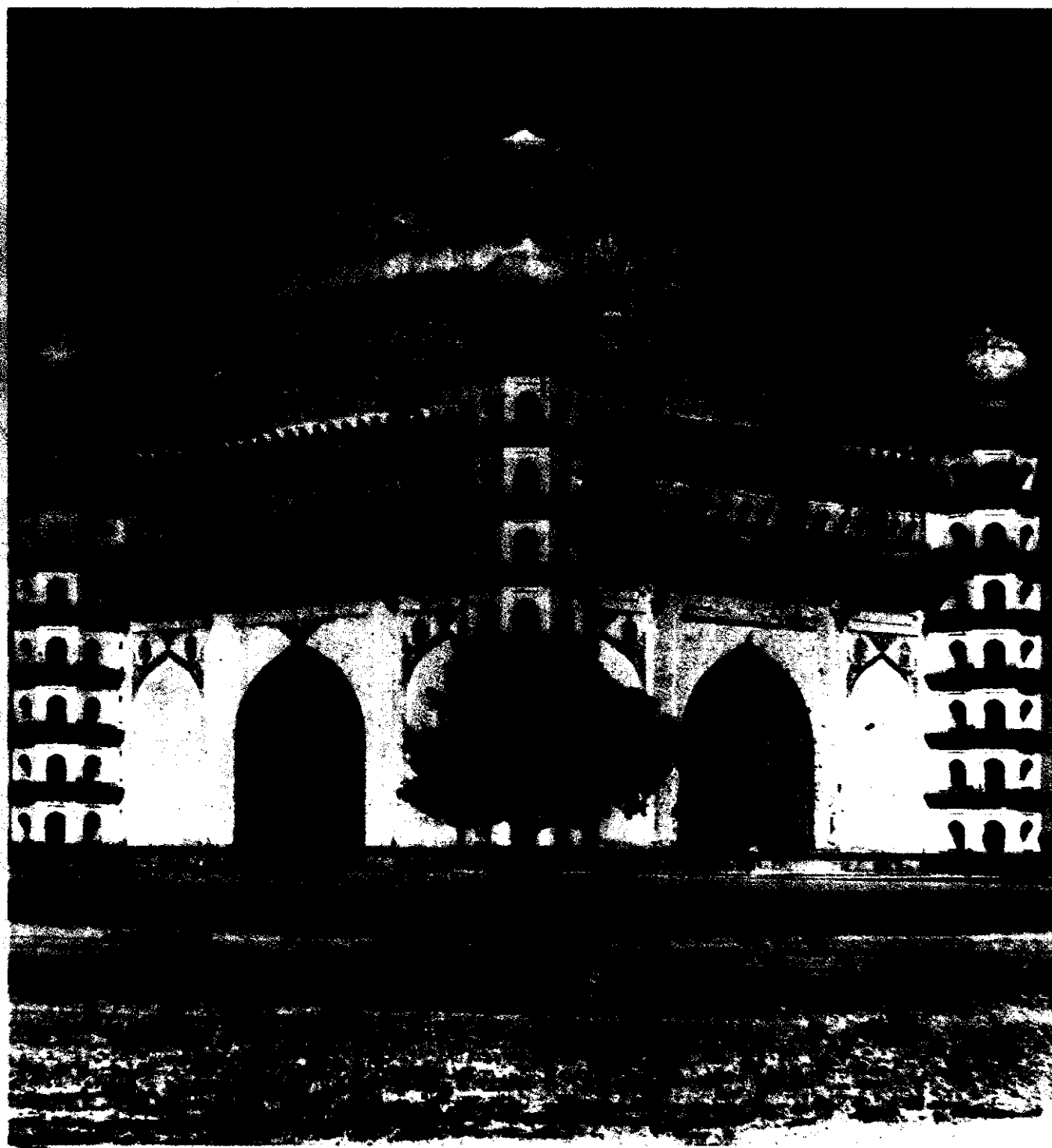

***Gole Gumbad***

## 6.4 GOLE GUMBAD

Title	-	Gole Gumbad
Medium	-	Baked bricks
Date	-	17th C.A.D.
Site	-	Bijapur
Size	-	Inner area 1600 sq. Meter

### General Description

During 14th century A.D., there were many small kingdoms especially in South India. One of these kingdoms was known as Bahmini Kingdom. Besides the Indian architectural style, the 'Gole Gumbad' of Bijapur had the influence of Egyptian, Turkish and Persian architecture as well which was built by the Bahmini king.

In the construction of Gole Gumbad, backed bricks have been used which have been cemented with lime stucco.

Muhammad Adil Shah of Bijapur built the Gole Gumbad in the 17th C.A.D.

It is situated at Bijapur city of Karnataka.

### STYLE OF CONSTRUCTION

The double layered roofing style of Iran has been used in construction of Gole Gumbad. In India, this is the biggest dome among all the domes of the world in which the inner layer of the dome is rounded in semi-circular form whereas the outer layer is conically narrowed upward giving it a bulbous look. There are four octagonal *minars* at the four corners which have seven storeys each. The inner area of this building is 1600 square meters.

---

### INTEXT QUESTIONS (6.4)

---

Tick mark (✓) the right answer

- (a) In the construction of Gole Gumbad the material is used.
- (i) Marble
  - (ii) Baked bricks
  - (iii) Granite
- (b) It was built by
- (i) Ibrahim Adil-Shah
  - (ii) Muhammad Adil Shah
  - (iii) Yusuf Adil Shah
- (c) It is situated at
- (i) Agra
  - (ii) Bijapur
  - (iii) Golconda
-

## 6.5 SUMMARY

After studying three historical monuments as given in the curriculum, you might have concluded that the history of medieval India is full of so many ups and downs on account of which a lot of cultural interaction took place which creates a large panoramic picture in front of us. In the history of architectural art of India during medieval period, the construction of *mehrab*s, domes and the mixtures of cementing mortars are the gifts of Turkish techniques. We can simultaneously very well see the *swastika* symbol, bell shape forms, lotus carvings and *kalash* (a pious earthen pituitary shapes) used as decorative motifs which are purely Indian in their style and form, gifted to the Indo-Islamic Architecture. Many tombs - *mehrab*s and *maqbaras* were constructed and their surroundings were developed into beautiful decorative parks/gardens. But special attention was laid on the strength of the buildings during construction time.

---

## 6.6 MODEL QUESTIONS

---

1. Keeping in mind the Indo-Turkish style of architectural art, explain the main features of the architecture of **Qutub-minar**.
2. Write down the three main reasons of calling '**Taj Mahal** as a very good example of Mughal architecture'.
3. The Dome of **Gole Gumbad** of Bijapur is a double layered roofing dome. Keeping this fact in mind draw a picture and write about the style of double layered bulbous dome.
4. Write the name and colour of stone used in the construction of **Taj Mahal**.

---

## 6.7 ANSWERS OF INTEXT QUESTIONS

---

- 6.2 (a) Victory, (b) Marble, (c) Indo Turkish Architecture  
6.3 (a) Memorial, Mumtaz, (b) Yamuna river, Agra, (c) White marbel stone  
6.4 (a) Baked bricks, (b) Muhammad Adil Shah, (c) Bijapur

## 6.8 GLOSSARY

Indo-Islamic	-	a new style in which elements are combined both from Indian and Islamic style.
Scriptures	-	religious book
Stucco	-	kind of plaster
Mortar	-	mixture of lime-sand and water used for cementing stone or circles in a building.
Inscription	-	writings on monument, metal plates, stone etc.

## 6.9 EXTENDED ACTIVITIES AND ABILITIES

If possible find out the occasion (s) of visiting DELHI, AGRA and BIJAPUR to have a first hand experiences of observing and enjoying the beauty of historical monuments like Qutab-minar, Taj Mahal and Gole Gumbad.

# Mughal School



332en07

## 7.0 INTRODUCTION :

Mughal evolution of miniature paintings was originated in Persia and continued for about three centuries in India. The tradition of miniature painting went on from one generation to another with fresh touch. The first Mughal emperor of India was Babur who was a man of aesthetic sensibilities. His son Humayun patronized the art of miniature painting and brought a few Persian artists to India. Notable names were Abdus Samad, Mir Sayyid Ali. It was from these artists that Humayun and his son Akbar took lessons in drawing.

The first major works of Mughal miniature were probably begun under Humayun but was completed under Akbar. During his period miniature paintings were lively and realistic and even contain elements of individual portraiture. After Akbar, his son Jahangir became the emperor. In his time mughal paintings achieved its zenith, both as decorative art and the nature study. Farukh Baigh, Aqa Raja, and Ustad Mansur were main painters during his period. Miniature paintings of the court of Jahangir's son, Shah Jahan show the first sign of decline.

Miniature paintings are small format of paintings which were usually executed with minute details. Paper was carefully burnished and preliminary drawing was made with red ink. Then the paper was coated with thin wash of white pigment. On this surface painting was done with tempera colours. Finally gold was used where necessary and complete painting was again burnished.

## 7.1 OBJECTIVES:-

After studying this lesson, the learner will be able to:

- explain briefly the background and evolution of Mughal miniature paintings.
- state the names of enlisted Mughal miniature paintings.
- identify the enlisted Mughal miniature paintings from others.
- mention the main characteristics of enlisted miniature paintings.
- describe the method and materials used, place and style of enlisted miniature paintings.
- name the artists of the enlisted paintings.

سبوطی سارو به لزان بوب برار سبده دسته اور سبان  
طاب پیچیده می برارند طاب همان طو پیچیده و گاداک می ایستد پدگ



Bird Catching at Baran

## 7.2 BIRD CATCHING AT BARAN

Title	-	<i>Bird Catching at Baran</i>
Artist	-	<i>Bhag</i>
Medium	-	<i>Tempra</i>
Period	-	<i>Akbar</i>
Style	-	<i>Miniature</i>
Collection	-	<i>National Museum, New Delhi</i>

### General Description

Manuscripts illustrated by the painters of the court of Akbar were the *Akbar Nama*, the *Razam Nama* (the Persian translation of the Mahabharata), *Anwar-i-Suhayli*, a book of fables and *Babur Nama*. A painting *Bird Catching at Baran* from Babur Nama has special mention. This painting in tempera technique was done on paper by Bhag. The painting is full of natural surroundings. A bird catcher has spread a net under a tree and is hiding behind the tree and covering himself with a red screen. In the foreground a pond is full of lotus flowers where a pair of hoopoes, sarus, snippets, duck and other birds have gathered to drink water. Few birds have fallen prey in the net. Indeed, this is a very beautiful study of birds. The appearance and colour of birds, trees, flowers and mountains are quit natural, which is a speciality of Akbar period.

### IN-TEXT QUESTIONS (7.2)

Fill in the blanks:

1. *Razam Nama* was illustrated during the period of \_\_\_\_\_.
2. Bird catching at *Baran* was done in \_\_\_\_\_ technique.
3. The name of artist of this painting is \_\_\_\_\_.

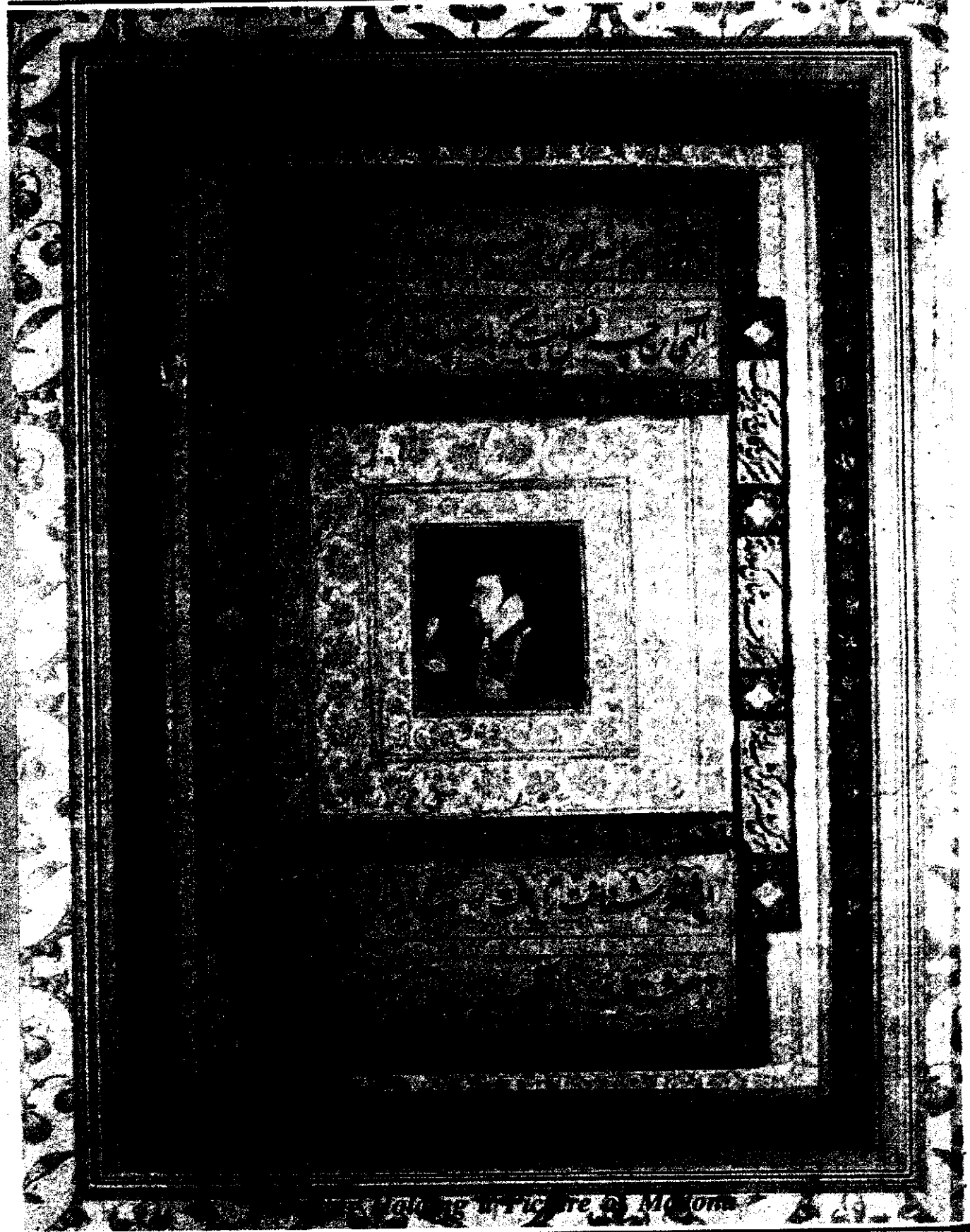

The Young Picture of Madonna



**7.3 JAHANGIR HOLDING A PICTURE OF MADONA**

<i>Title</i>	-	<i>Jahangir holding a picture of Madona</i>
<i>Artist</i>	-	<i>Abul Hasan</i>
<i>Medium</i>	-	<i>Tempera</i>
<i>Style</i>	-	<i>Miniature</i>
<i>Collection</i>	-	<i>National Museum, New Delhi</i>
<i>Period</i>	-	<i>Jahangir</i>

**General description**

Abul Hasan did portrait of *Jahangir holding a picture of Madona* in 1620. As tempera on paper was common in practice, this painting is also done in same technique. Jahangir is shown holding a picture of Madona and having a close look at it. Jahangir is painted in the centre with decorated borders with scripture on some of it. This painting has an influence of western style. The portrait in profile has prominent nose, big head, soft colours and golden appearance, which is the main characteristics of Jahangir school.

**IN TEXT QUESTIONS : (7.3)**

Mark (✓) against correct answer of the following questions:

- Jahangir holding the picture of Madona is painted by :  
(A) Ustad Mansur (b) Abul Hasan (C) Abdus Samad
- The portrait of Jahangir was done in :  
(A) Profile (B) Front (C) Semi-profile.
- The portrait has  
(A) Prominent ear (B) Prominent eye (C) Prominent nose

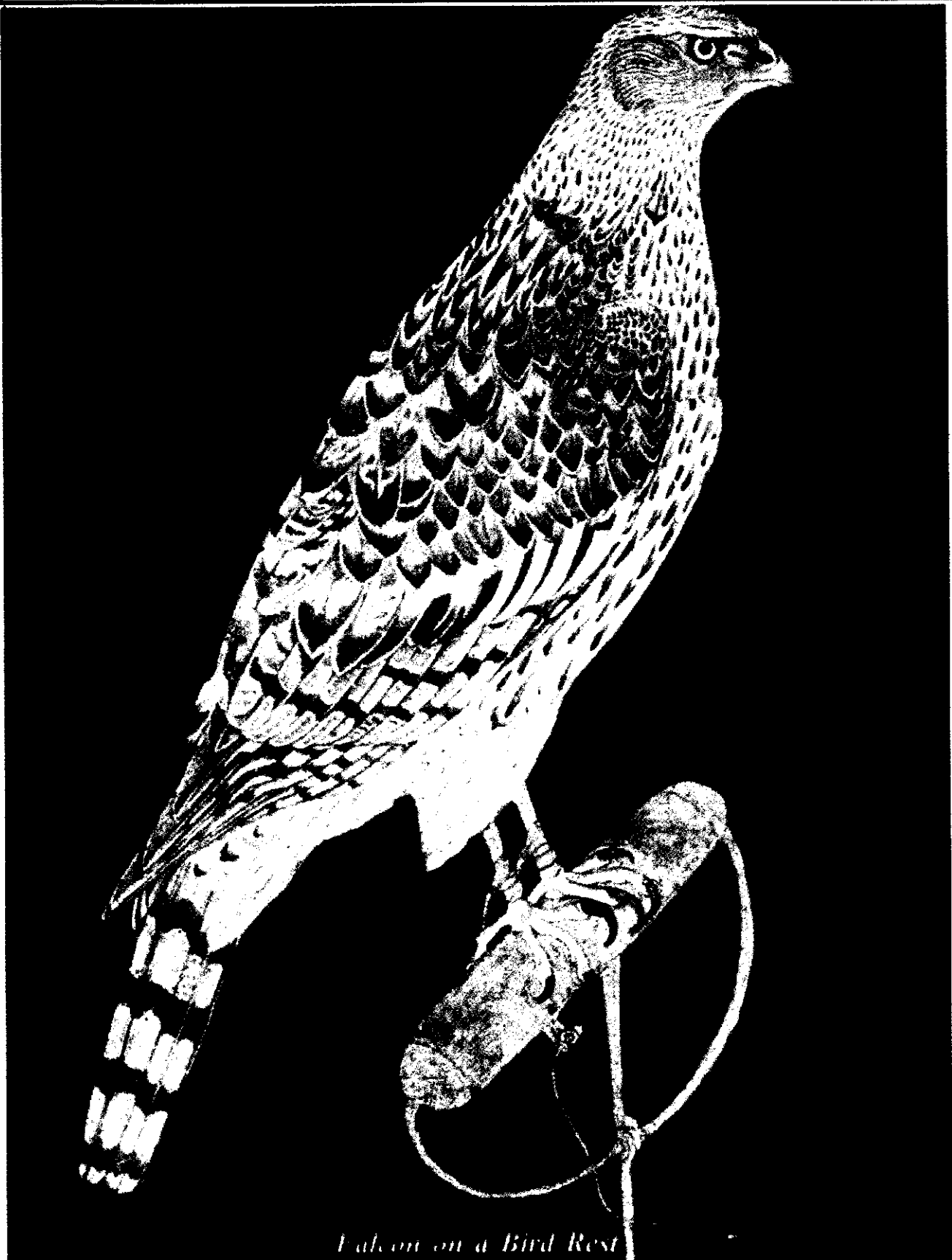

*Falcon on a Bird Rest*

## 7.4 FALCON ON A BIRD REST

<i>Title</i>	-	<i>Falcon on a Bird Rest</i>
<i>Artist</i>	-	<i>Ustad Mansur</i>
<i>Medium</i>	-	<i>Tempera</i>
<i>Style</i>	-	<i>Miniature</i>
<i>Time</i>	-	<i>Jehangir</i>
<i>Collection</i>	-	<i>National Museum, New Delhi.</i>

### General Description

Ustad Mansur was one of the notable painters in Jehangir court. He was chiefly known for his wonderful studies of bird life but he was also one of the best Mughal portrait painters. There was no doubt the practice of drawing from live model familiar during Jehangir which led to remarkable achievement in portraiture. 'Falcon on a Bird Rest' is a superb example of Ustad Mansur's work. Detailed study of Falcon is easily noticeable in this painting. It seems that this falcon is a tamed bird and painted in tempera technique with realistic details. The falcon is painted in white and brown colours against a contrast yellow background. Its sharp beak and round vigilant eyes are painted in shades of deep yellow ochre. A patch of light blue delineates the feathers on the back of its neck. The bird is fastened with a weight and a string hanging beautifully around its neck. Probably this falcon was a gift from Shah Abbas, the emperor of Iran.

---

### IN TEXT QUESTIONS (7.4)

---

Mark (✓) against correct answer of the following questions:

- Falcon on a bird rest is a painting in  
(A) Realistic style (B) Abstract style (C) Semi realistic style
  - The falcon is painted in  
(A) Red & blue colours (B) Brown & White colours (C) Brown & Red colours
  - Ustad Mansur was chiefly known for his  
(A) Landscape study (B) Bird life study (C) Foliage study.
  - Practice of drawing from living model was familiar during  
(A) Akabr period (B) Jehangir Period (C) Humayun period.
-

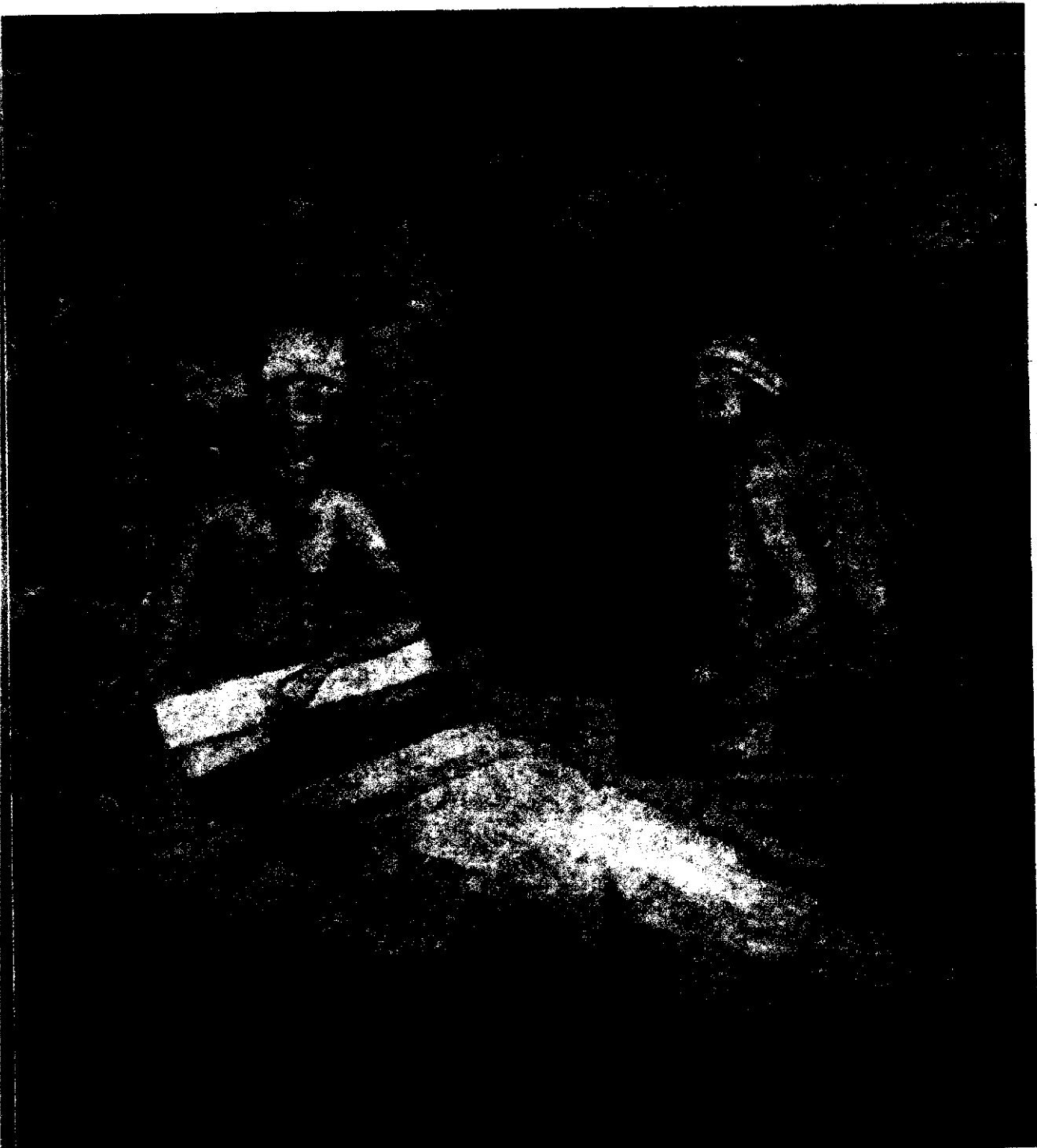

*Kabir and Raidas*

<i>Title</i>	-	<i>'Kabir and Raidas'</i>
<i>Artist</i>	-	<i>Faqir - Ullah</i>
<i>Medium</i>	-	<i>Tempra</i>
<i>Style</i>	-	<i>Miniature</i>
<i>Period</i>	-	<i>Shah Jahan</i>
<i>Collection</i>	-	<i>National Museum, New Delhi</i>

### General description

The period of Shah Jahan was an age of gold. But during his time miniature paintings first shows the sign of decline. The works are perfect but lifeless.

Under Shah Jahan the pattern set under Jahangir was followed in both miniatures and manuscript illustrations. Portraits continued to occupy much of the time of the court painters. There was more feminine touch, an added softness in the drawing of portraits. A new tendencies of naturalism in figure drawing and realistic drapery was developed.

The painting 'Kabir and Raidas' is a documented example of respect given to religious saints by Mughals. Ustad Fakir - Ullah did this tempera painting on paper. He was the head painter of Shah Jahan's Workshop. In a rural background saint Kabir is painted, besides his hut, weaving. The portraits of Kabir and Raidas are realistic study, while the background fades in the mist. Saint Raidas is sitting close by with a *mala* of beads. Both are in deep meditation. There is a divine peace on their faces. This painting brings forth the simple and peaceful life in Indian village. A blue border focuses the painting which is painted in brown shades.

### IN TEXT QUESTIONS (7.5)

Circle the correct answer of the followings:

- The border of the painting is painted in  
(A) Blue shades (B) Green shades (C) Brown shades
- 'Kabir and Raidas' was painted by  
(A) Fakir - Ullah (B) Nadir (C) Mansoor
- The period of Shah Jahan was the period of  
(A) Bronze (B) Silver (C) Gold

*Marriage Procession of Dara Shikoh*



## 7.6 MARRIAGE PROCESSION OF DARA SHIKOH

<b>Title</b>	:	<i>"Marriage Procession of Dara Shikoh"</i>
<b>Artist</b>	:	<i>Haji Madani</i>
<b>Medium</b>	:	<i>Tempra</i>
<b>Style</b>	:	<i>Miniature</i>
<b>Period</b>	:	<i>Awadh school</i>
<b>Collection</b>	:	<i>National Museum, New Delhi.</i>

### General description

Provincial art in Awadh became very powerful under Nawab Shuja-ud-Daula. It reached at its peak under Wajid Ali Shah. While keeping the basic Mughal style, the Awadh school developed a style of its own. There was tremendous emphasis on decoration and colours were softer.

'Marriage Procession of Dara Shikoh' was painted by Haji Madani on paper in tempera technique. In this painting Dara Shikoh with his *baratees* is riding on horse back. The prince is leading the procession. There are joyful men, women and young boys who are largely waiting for them. Dara Shikoh is wearing an *angarakha* and a veil of pearls. His father Shah Jahan who is shown with a halo around his head follows him. All the faces are shown either in profile or semi profile. The women are shown riding on elephants in the background. Alongside the drummer are beating their drums sitting on elephants. The dancing, clapping and singing crowds are dressed in bright colourful clothes decorated with gold. Some of the men from both the sides are holding candles. The perspective in the painting is maintained carefully. This painting depicts all flora and fauna.

### IN TEXT QUESTIONS (7.6)

Fill in the blanks :

1. Marriage Procession of Dara Shikoh is painted by \_\_\_\_\_.
2. Shah Jahan is shown with a \_\_\_\_\_ around his head.
3. Women are shown riding on \_\_\_\_\_.
4. Provincial art reached at its peak under \_\_\_\_\_.

### 7.7 SUMMARY :

The first major works of Mughal miniature were probably begun under Humayun but was completed under Akbar. There were a few Persian artists along with Abdus Samad, Mir Sayyid Ali. During the period of Jehangir, the miniature paintings achieved its zenith both and decorative in study of nature. Farukh Baigh, Aqa Raja, Ustad Mansur were main painters in Jehangir's studio. Most of the paintings were executed in tempera technique in Shah Jahan's period. There were tremendous use of gold with lot of decoration keeping the mughal style. The Awadh school developed a style of its own.

---

**7.7 MODEL QUESTIONS:**

---

Give brief description of the following:

1. Write the technique used in miniature painting.
  2. Describe the painting 'Falcon on the bird rest'.
  3. Write the characteristics of Mughal Miniature painting.
  4. Write on any painting done during Shah Jahan's period.
  5. Describe the painting 'Marriage Procession of Dara Shikoh'.
- 

**7.8 ANSWER OF IN TEXT QUESTIONS**

---

- 7.2 (1) Akbar (2) Tempera (3) Bhag  
 7.3 (1) B, (2) A, (3) C  
 7.4 (1) A, (2) B, (3)B, (4) B  
 7.5 (1) C, (2) A, (3) A  
 7.6 (1) Hazji Madani (2) halo (3) Elephants (4) Wajid Ali Shah

**7.9 GLOSSARY**

- |                         |  |
|-------------------------|--|
| Persia                  | - an ancient empire located in west and south west asia.   |
| Tradition               | - from generation to generation  |
| Aesthetics              | - study of art in relation to the sense of beauty  |
| Patronize               | - To support   |
| Realistic               | - based on what is real and practical  |
| Portraiture             | - Study of the likeness of a person  |
| Zenith                  | - highest point of state   |
| Decline                 | - downward movement  |
| Executed                | - done   |
| Preliminary             | - first step   |
| Pigment                 | - colour   |
| Tempera                 | - any paint in which pigment is tempered (mixed) with a water - based binding medium-usually egg yolk. |
| Madonna                 | - Virgin Mary  |
| Contrast                | - uses of opposite colour  |
| Delineate               | - to trace the outline   |
| Manuscript illustration | - hand written book illustration   |
| Naturalism              | - technique of rendering a subject as natural appearance   |
| Drapery                 | - dress  |
| Provincial              | - belonging to a particular province (area)  |
| Emphasis                | - giving importance  |
| Angarakha               | - dress  |
| Halo                    | - circle or ring around the head of a sacred person  |
| Perspective             | - technique of showing volumes and special relationship on a flat surface (paper).                     |





# Rajasthani School of Painting

## 8.0 INTRODUCTION

Rajasthani painting flourished from 16th C.A.D to 19th C.A.D. It was inspired and influenced by Jain manuscript painting of Gujarat. This painting style matured during 17th C.A.D. Its popularity spread all over Rajasthan and attained the appreciation of the common man and the royal court equally. Though the technique and style remained basically the same as that of mural of the classical period, but it borrowed few things from Mughal painting in the later period.

Rajasthani painting can be divided in four groups as Rajasthani School, Bundelkhand School, Pahari School and Sikh School. There are many centres in these regions, which are famous for these miniature paintings. Some of these centres are, Jaipur, Mewar, Malwa, Nathdwara, Udaipur, Jodhpur, Bikaner, Kota, Bundi, Kishengarh etc.

Themes of these paintings are mainly Puranic or Epic. Krishna-Leela is the most popular theme along with some stories of the Mahabharata and Ramayana. Folk lore of Rajasthan like Dhola-Maru and Roopmati and Baajbahadur are also illustrated in these paintings.

### Characteristic Features

There is a lot of variety in the style of Rajasthani School in handling the natural scene, architectural structure and human figures.

Faces are generally shown in profile. Both the male and female figures show suppleness and emotion in their large eyes. The influence of the Mughal court is very clear in the dress and costumes. Same influence is notable in the drawings of building and palaces in these paintings during the later period.

## 8.1 OBJECTIVES

After studying this lesson, learner will be able to:

- describe the background, region, religious movements and influence of literature on the painting style;
- describe the enlisted art works with appreciation;
- differentiate the different styles of Pahari and Rajasthani School of painting;
- explain the characteristic features of these paintings;
- know about the medium, technique and style of the miniature paintings;
- know about the artists of these paintings and their names.



Meru Ray

## 8.2 MERU RAGINI

<i>Title</i>	-	<i>Meru Ragini or Maru Ragini</i>
<i>Medium</i>	-	<i>Tempera on hand made paper</i>
<i>Date</i>	-	<i>Circa 1650 A.D</i>
<i>Size</i>	-	<i>6"X8"</i>
<i>Theme</i>	-	<i>Story of Dhola Maru</i>
<i>Artist</i>	-	<i>Sahibdin</i>
<i>Collection</i>	-	<i>National Museum, New Delhi</i>

### General Description

The love Story of Dhola Maru is very popular in Rajasthan and is narrated both in Murals and miniature paintings.

The composition of this painting is divided into two parts. Dhola and Maru are shown seated under a yellow canopy with a red curtain in the upper part of the composition. Dhola is dressed in typical aristocratic attire complete with weapons like sword and shield, facing his lover Maru in Rajasthani costume. The lower part of the composition shows Maru caressing her pet camel. Both the figures are prominent against a green background dotted with flower motifs. Stylised motifs of three trees are bringing a unity in the composition.

---

### IN TEXT QUESTIONS (8.2)

---

Choose the right answer:-

- (a) The story of Dhola-Marua is popular in \_\_\_\_\_.
- (i) Bengal
  - (ii) Punjab
  - (iii) Bihar
  - (iv) Rajasthan
- (b) The date of this painting is \_\_\_\_\_.
- (i) 1880A.D
  - (ii) 1710 A.D
  - (iii) 1650 A.D
- (c) The composition of this painting is divided in \_\_\_\_\_.
- (i) Two parts
  - (ii) three parts
  - (iii) four parts
-



*Radha and Krishna (offering betel leaf to each other)*

### 8.3 Radha and Krishna Offering betel leaf to each other

Title	-	Radha and Krishna
Medium	-	Tempra on hand made paper
Date	-	Between 1735 A.D to 1750 A.D
Size	-	42X25 cm.
Theme	-	Paan Mehphil.
Artist	-	Nihalchand
Collection	-	National Museum, New Delhi

#### General Description

Radha and Krishna are dancing on a bed covered with a white sheet and offering *paan* (betel) to each other. They are attended by maid servants or *Gopinis*. There are some musicians to entertain them.

The painting is rendered in traditional Kishangarh style, which is particularly noticeable in the drawing of the eyes, nose and costume. The painting is one of the master pieces by famous painter Nihalchand. The colourful dresses of the figures are admirably set off by the chalky whiteness of the buildings in the background beyond the vast panorama of the lake. The suggestion of hills and jungles in the foreground gives a sense of depth in the space.

---

#### INTEXT QUESTION (8.3)

---

Fill up the blanks:-

- The painting is rendered in \_\_\_\_\_ style.
  - This is a masterpiece by famous painter \_\_\_\_\_.
  - The theme of the painting is \_\_\_\_\_.
-



*Meeting of Rama and Bharata at Chitrakoot*

## 8.4 MEETING OF RAMA AND BHARATA AT CHITRAKOOT

<i>Title</i>	-	<i>Bharat Milap</i>
<i>Medium</i>	-	<i>Tempera on hand made paper</i>
<i>Date</i>	-	<i>1740 A.D</i>
<i>Style</i>	-	<i>Jaipur School</i>
<i>Theme</i>	-	<i>Rama meets Bharata at Chitrakoot</i>
<i>Artist's Name</i>	-	<i>Guman</i>
<i>Collection</i>	-	<i>National Museum, New Delhi</i>

### General Description

This one is a very popular episode of Ramayana, largely known as 'Bharat-Milap'. The painting depicts the emotional moment when Bharat, the younger brother of Rama is trying to take him back home. The whole incident is taking place at the jungle of Chitrakoot where Rama stayed for few days. The artist has created a perfect atmosphere of hermitage with a small hut and different kinds of plants and trees. The serenity and simplicity of the landscape enhances the mood of the painting.

### INTEXT QUESTIONS (8.4)

Fill up the blanks -

- The date of this painting is \_\_\_\_\_.
- The painting belongs to \_\_\_\_\_ school.
- This painting is painted by \_\_\_\_\_.

*Vani Thani of Kishangarh School*





**BANI THANI OF KISHANGARH SCHOOL**

<i>Title</i>	-	<i>Bani Thani</i>
<i>Date</i>	-	<i>1750 A.D</i>
<i>Medium</i>	-	<i>Tempera on hand made paper</i>
<i>Size</i>	-	<i>19 cm x 25 cm</i>
<i>Style</i>	-	<i>Kishangarh school</i>
<i>Artist's name</i>	-	<i>Nihal Chand</i>
<i>Collection :</i>	-	<i>National Museum, New Delhi</i>

**General Description**

This painting by Nihalchand of Kishangarh of Rajasthani School has a special place in the treasure of Indian miniature painting. The style is characterized by emphatic lengthening of the eyes and nose. Faces are mostly in profile with a very stylized eye brow and smile on the lips. The painter was inspired by the poem of Raja Sawant Singh, who describes the beauty of a lady called "Vani Thani" in his poem. The beauty of this woman is symbolically used to describe the beauty of Sri Radha. As a master painter Nihalchand could go beyond the mundane to the spiritual in this portrait. The smile of Vani Thani is often compared with the smile of Mona Lisa.

**INTEXT QUESTIONS: (8.5)**

Fill up the blanks

- (a) The date of the painting Vanithani is \_\_\_\_\_.
- (b) The artist of this painting is \_\_\_\_\_.
- (c) This painting is painted in \_\_\_\_\_ style.

## 8.6 SUMMARY

Rajasthani painting flourished from the 16th-19th centuries in the areas like Rajwara, Rajasthan, Rajputana etc. The Rajasthani miniature painters assimilated different styles and techniques both from the old school like, Ajanta, Gujrati palm-leaf painting and contemporary styles of Persia, Mughal and even European art. The early Rajasthani painting schools like Mewar, Bundi, Malwa, Bikaner, Kishangarh and other small city-states became prolific centres of this style. Various themes were used by these painters, which included Ramayana, Mahabharata, Geeta-Govindam, life of common people and local love-stories.

---

## 8.7 MODEL QUESTIONS

---

1. Mention the themes of Rajasthani painting.
2. Name the important centres of Rajasthani paintings.
3. Describe the painting on the story of Dhola-Maru.
4. Describe the characteristic features of the painting "Vani-thani".

---

## 8.8 ANSWERS OF INTEXT QUESTIONS

---

- 8.2 (a) Rajasthan (b) Circa 1650 A.D (c) Two parts
- 8.3 (a) Kishangarh style (b) Nihalchand (c) Radha and Krishna are offering *paan* to each other.
- 8.4 (a) 1740 A.D (b) Jaipur (c) Guman
- 8.5 (a) 1750 A.D (b) Nihalchand (c) Kishangarh style

## 8.9 GLOSSARY

1. Mural - Wall painting
2. Miniature painting - small size painting.
3. Tempera - painting with pigments mixed with egg on other binder. Opaque in nature.
4. Manuscript - book written by the hand.
5. Profile - sideface
6. Ragini - Indian form of music
7. Fore ground - front part of the space
8. panorama - a wide view



# Pahari School of Miniature Painting

## 9.0 INTRODUCTION

A new style that was developed in the Himalaya foot-hills of Punjab, Garhwal and Jammu is known as "Pahari Qualam" or Pahari school of painting. The local folk art form of this area was influenced by painters of Mughal court when they took shelter in the Hindu states of this area due to the invasion of Nadir Shah. Pahari Qualam is a beautiful combination of natural beauty of this region and the glamour of Mughal court of Delhi. Under the patronage of the small kings of the hill-states, it spread through Jammu to Tehri and Pathankot to Kullu. The painters maintained the indigenous style in spite of the Mughal influence. The Pahari school narrates Indian Mythological and religious stories. Portrait paintings were also very popular among the patrons of this school. Though the characters are from Hindu religious stories, they are sometimes shown in Mughal costumes. The artists of Jammu, Kangra and Guler combined the best aspects of Mughal and Rajasthan styles. The main centres of Pahari school were Basholi, Guler, Kangra, Chamba, Mandi, Kullu, Bilaspur, Jammu, Nalagarh, Garhwal, Kashmir, Dharamshala etc.

Themes of Pahari miniature paintings are influenced by classical literature, music and local cultures. The painters are masters in expressing the beauty of nature and women.

These paintings are done on handmade paper, which is made of bamboo, cotten and other materials. These are popularly known as "Sialkoti paper". After the lines are drawn on the paper, it is given a coat of white colour. The surface of the paper is polished by rubbing a smooth stone on it and colours are applied on this surface. The painters also used stencils to reproduce more copies of the painting.

Pahari school began to decline in the 19th C.A.D., not before it achieved excellence in the art of miniature painting. The school is characterised by its tender colouring, sensitive and emotional style and more convincing use of perspective and foreshortening.

### 9.1 OBJECTIVES

After studying this lesson the learner will be able to -

- describe the background, region, contribution of Mughal court, religions and literature;
- describe the enlisted art-works with appreciation;
- differentiate between the styles of Rajasthani school and Pahari school;
- explain the characteristic features of these paintings;
- identify the medium, technique and style of Pahari school painting;
- state of the names of painter's and their paintings.



## 9.2 KRISHNA WAITING FOR RADHA

<i>Title</i>	-	<i>Krishna waiting for Radha</i>
<i>Medium</i>	-	<i>Tempera on Sialkoti paper</i>
<i>Period</i>	-	<i>1730 A.D.</i>
<i>Size</i>	-	<i>12.2"x8.1"</i>
<i>Theme</i>	-	<i>A very popular theme of Krisna Leela</i>
<i>Style</i>	-	<i>Basholi</i>
<i>Artist</i>	-	<i>Manku</i>
<i>Technique</i>	-	<i>Tempera</i>
<i>Collection</i>	-	<i>National Museum New Delhi</i>

### General Description

"Geet Govinda" was written by Bengali poet Jaidev on 'Krisna-Leela' during 11th C.A.D. and became very popular all over India. The painters of Basholi were influenced by poetic descriptions of "Krisna-Leela" and used these most romantically in their paintings. This painting is one of those, in which Krisna, Radha and her friends are shown. The allegorical presentation of Krisna and Radha as *Paramatma* (Supreme being) and *Atma* (human being) respectively and the Gopinis (friends) as '*Guru*' (Preceptor), elevate the theme to a spiritual level. The *Guru* persuades a person to meet "*Paramatma*", as Gopinis are trying to convince Radha to meet waiting Krishna.

Basholi paintings are characteristic by flat backgrounds with simplified forms of trees. Faces are in profile and colour are warm and bright.

### INTEXT QUESTIONS (9.2)

Choose the right answer

- (a) This painting belong to the style of
- Kishan garh
  - Basholi
  - Chamba
- (b) The painter was inspired by the following book
- Shri Madbhagavat
  - Mahabharata
  - Geeta-Govinda
- (c) Match the following
- |              |                 |
|--------------|-----------------|
| (i) Radha    | (i) Atma        |
| (ii) Krisna  | (ii) Guru       |
| (iii) Gopini | (iii) Paramatma |

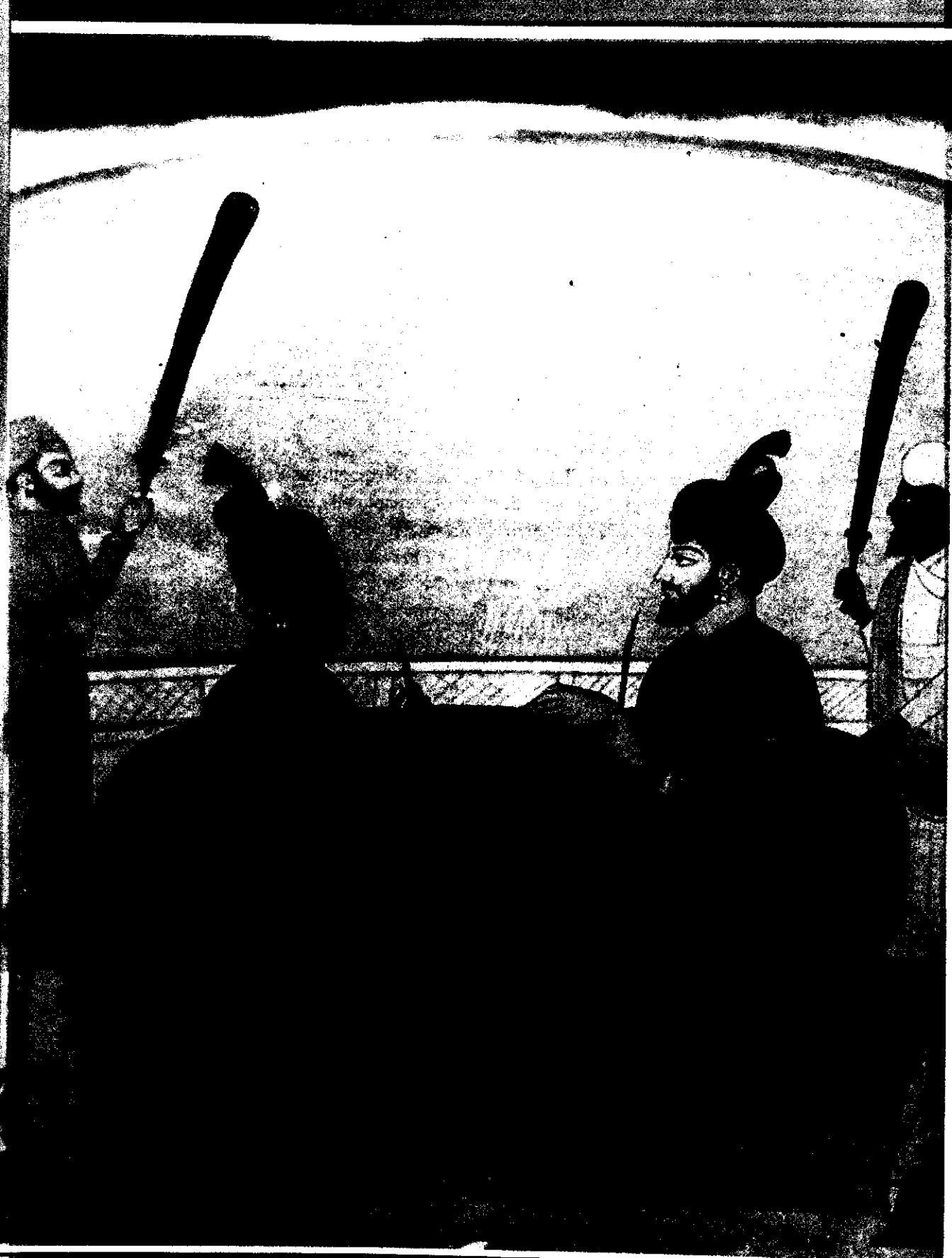

### 9.3 KING OF CHAMBA JIT SINGH AND KING OF KANGRA SANSAR CHAND

<i>Title</i>	- <i>King of Chamba and king of Kangra</i>
<i>Medium</i>	- <i>Water colours</i>
<i>Period</i>	- <i>Circa 1800 A.D</i>
<i>Size</i>	- <i>28.5 X 22cm.</i>
<i>Theme</i>	- <i>Chamba king Jeet Sing and Kangra king Sansar Chand in a courtesy meeting</i>
<i>Technique</i>	- <i>Tempra</i>
<i>Material</i>	- <i>Paper (hand made)</i>
<i>Artist</i>	- <i>NainSukh</i>
<i>Collection</i>	- <i>National Museum, New Delhi</i>

#### General Description

Raja Sansar Chand was a great admirer and patron of art. His time was a golden age of Indian painting of the pahari school. The painting documents the friendship of two rulers of Pahari States and art-lovers. Raja Jeet Singh of Chamba and Raja Sansar Chand are relaxing and smoking from Hukka. In a background of yellow space and blue sky, the Royal costumes appear very colourful. The kings are flanked by attendants. This is a very good example of portraiture of pahari school of Kangra.

#### INTEXT QUESTIONS: (9.3)

Fill up the blanks

- This painting is painted by \_\_\_\_\_.
- This painting belongs to \_\_\_\_\_ school.
- The enlisted painting is a good example of \_\_\_\_\_ Pahari School.

#### 9.4 SUMMARY

Pahari School of painting is quite distinct from Rajasthani school. This region was more exposed to different religious beliefs and Mughal influence. The school is famous for beautiful flowing lines and brilliant colours. The court painting of portraits become popular along with literary, mythical and secular themes. The painters of Pahari School were great lovers of nature and depicted nature with care and love in their paintings.

---

#### 9.5 ANSWER OF INTEXT QUESTIONS.

---

- 9.2 (a) (ii) Basholi  
(b) (iii) Geeta Govinda  
(c) Radha - Atma  
Krisna - Paramatma  
Gopini - Guru
- 9.3. (a) NainSukh  
(b) Pahari School  
(c) Portraiture

---

#### 9.6 MODEL QUESTIONS

---

1. Describe the main theme of Pahari painting.
2. What do you know about the characteristic features of Pahari painting.
3. Describe the painting "Krisna is waiting for Radha".
4. Throw some light on the technique of Pahari miniature painting.

---

#### 9.7 GLOSSARY

- Krishna-Leela - Different stories about Krishna
- Allegorical - 1. Symbolic narration 2. Picture reverting a hidden meaning
- Secular - Non religious subjects
- Foreshorten - 1. Represent as having less depth or distance than reality, so as to convey an effect of perspective.  
2. Shorten or reduce in time or scale.





# Deccan School of Painting

## 10.0 INTRODUCTION

The plateau region in South India between the Narmada river and Krishna river is called Deccan. This region continued the indigenous Hindu tradition under the powerful rule of the Vijayanagar kings, while Muslims dynastic were ruling the Northern part of India during 14th C.A.D. Heritage of the painting style is rooted both in the Deccan and South. Art of painting flourished also under the Bahmini ruler in the Deccan. Nagara, Bijapur and Golconda style of painting are also rooted in this region. All these painting style shared the stylistic features with painting traditions of Western and Northern India. The Tanjore school of Painting, on the other hand, develop an original style with a difference.

## 10.1 OBJECTIVES

After studying this lesson the learner will be able to :

- describe the development of the Deccanese art;
- name the titles of the enlisted paintings of Deccan;
- differentiate between the paintings of Deccan with other Indian paintings;
- explain characteristic features of these paintings;
- write about the medium, technique and style;
- state the name of the artists.

*Nizamuddin Auliya and Amir Khusrau*



## 10.2 NIZAMUDDIN AWALIYA AND AMIR KHUSRAU

Title - Nizam-ud-din Awalia and Amir Khusrau

<i>Medium</i>	-	<i>water colour on hand - made paper</i>
<i>Period</i>	-	<i>circa 18th C.A.D</i>
<i>Size</i>	-	<i>29 X 22 cm.</i>
<i>Style</i>	-	<i>Hyderabadi school</i>
<i>Artist</i>	-	<i>Unknown</i>
<i>Technique</i>	-	<i>Tempera</i>
<i>Collection</i>	-	<i>National Museum, New Delhi</i>

### General Description

The Sufi Saint Nizam-ud-din Aulia is enjoying a Sufi song from his disciple Amir Khusru. The halo around the head of the Saint expresses his spiritual attainment and wisdom. A serene and peaceful atmosphere is created by the painter with a garden and single tree in the background. The facial expression and posture of the body of Nizam-ud-din give the impression that he is lost deeply into the music.

### INTEXT QUESTION (10.2)

Choose the right answer

- (a) One of the paintings of Deccan School show the famous pair of Guru and desciple like
- (i) Guru NanaK and Mardana
  - (ii) Nizam-du-din and Amir Khusru
  - (iii) Ravidas and Kabir
- (b) The style of this painting belongs to
- (i) Tanjore school
  - (ii) Hyderabadi school
  - (iii) Bijapur school
- (c) The painting's date is
- (i) 8th C.A.D
  - (ii) 19th C.A.D
  - (iii) 18th C.A.D



### 10.3 TANJORE PAINTING

<i>Title</i>	-	<i>Goddess Saraswati</i>
<i>Medium</i>	-	<i>Water colour on board with semiprecious gems/Mix-Medium</i>
<i>Date</i>	-	<i>19th century</i>
<i>Size</i>		
<i>Style</i>	-	<i>Tanjore school</i>
<i>Artist</i>	-	<i>Chitra gara Krishna Appa</i>
<i>Collection</i>	-	<i>National Gallery of Modern Art, New delhi (ACC 2265)</i>

#### General Description

Tanjore paintings are different from any other painting style because of its embellishment over the basic drawing with precious and semi-precious stone as well as the relief work.

This art originated in Thanjavoor (Tanjore) in Tamil Nadu during 16th C.A.D., but most of the extant works belong to 19th C.A.D. This style became very popular in the surrounding regions, and spread all over the Deccan. The popular theme have been Krishna, Radha, Vishnu and Ganesha.

This is a painting of Devi Saraswati, the goddess of learning seating on a throne. She has four arms. She is playing a "Veena" The painting is highly ornamental and colourful. Classical Indian motifs are used with very minute details.

---

#### INTEXT QUESTIONS (10.3)

---

Choose the right answer:-

- (a) Tanjore paintings are different because of its
- (i) embellishment with gems
  - (ii) lines and colours
  - (iii) themes.
- (b) This art was originated in
- (i) Vijaya nagar
  - (ii) Tamil Nadu
  - (iii) Gujarat
- (c) The enlisted painting of Saraswati is decorated with
- (i) Persian motifs
  - (ii) Western motifs
  - (iii) Indian classical motifs
-

#### **10.4 SUMMARY**

During the medieval period, some states in the Deccan became enough powerful to bring peace in their areas, and developed art and architecture. The kings of Vijayanagar, Behmini and some Hindu rulers patronized the art of painting which was influenced by Mughal miniature and Rajput miniature styles. In the same time few indigenous styles also flourished. Tanjore painting is one of these.

---

#### **10.5 ANSWER OF INTEXT QUESTIONS:**

---

- 10.2 (a) Nizam-ud-din and Amir Khusru  
(b) Hyderabad School  
(c) 18th C.A.D
- 10.3 (a) Embellishment with gems  
(b) Tamil Nadu  
(c) Indian classical motifs

---

#### **10.6 MODEL QUESTIONS**

---

1. How did Deccan art flourish during the medieval period?
2. Describe the theme of the enlisted painting from Hyderabad.
3. Why Tanjore painting is different from other schools of painting?

#### **10.7 GLOSSARY**

Sufi - mystical muslim sect.

Embellishment - decoration

Motifs - repetition of a form in a design



## Company School

### 11.0 INTRODUCTION

The British traders reached India in the last decade of the sixteenth century and this trade was put on a strong footing. Other companies from United Netherlands and France followed the British. In time, the British became the major power in India by defeating the rival French at Plassy in 1757. In 1765 Lord Clive was granted authority by the Emperor of England to collect taxes in the eastern provinces through the East India Company bypassing the Nawab of Bengal.

The term '**Company painting**' has come to be used by art historians for a special type of Indian painting which was produced for Europeans and was heavily influenced by European taste. Although many different Company styles developed in different parts of India, the term covers a single phenomenon: an attempt by Indian artists to work in a mixed Indo-European style which would appeal to the Europeans who were employed by the various East India companies; hence the name.

This was the time when the art of the Mughals and Rajput miniatures had become exhausted. Indian artists were recruited by the East India Company for drawings blue prints for railway projects, and natural history surveys or freelancing for British civilians who wanted to take home souvenirs.

Apart from the merchants and officials of these companies, various other European travellers, adventurers made their way to India. The British soon found that the Indian subjects could be depicted far more accurately by Indian artists, to whom these subjects were familiar than by themselves and hired Indian artists to paint for them. The direct influence of Europeans produced a new style of watercolour painting including western perspective and shading.

Many painters from Murshidabad migrated to Patna (now the capital of Bihar) around 1760. By the end of the century, this city became the headquarters of one of eleven areas of art centres into which the British East India Company divided Bengal. This is known as the Company school of painting from the fact that its patrons belonged to the East India Company. This style is also known as Patna school.

Inspired by the trends, artist families in places such as Tanjore, Trichinopoly, Delhi, Murshidabad, Patna, Calcutta, Banaras and Lucknow, all produced paintings of subjects of local interest in distinctive local styles. They began to work in water colour rather than gouache; they often modified their colour range, and preferred more muted colours of the European engravings. Both subject-matter and style were influenced by the English watercolours and prints which the artists saw around them in increasing numbers.

The portraits produced at the end of the eighteenth century show sharp features and the use of very thick lines to define the eyes. Other miniatures show small, squat figures, whose faces are modelled with brown wash instead of the earlier stipple.

### 11.1 OBJECTIVES

After studying this module the learner will be able to:

- explain the influence of colonial art and culture on Indian paintings;
- write the name of colours used in paintings of the period;
- identify the artist of enlisted paintings of Company school;
- mention the main characteristics of Company school paintings;
- describe method and materials used, place, and style of enlisted paintings;
- describe the details of paintings of the periods.





## 11.2 A GROUP OF KASHMIRI ARTISANS

<i>Title</i>	-	<i>A Group of Kashmiri artisans</i>
<i>Period</i>	-	<i>Mid 18th century (1850)</i>
<i>Artist</i>	-	<i>Unknown</i>
<i>Medium</i>	-	<i>Water colour</i>
<i>Style</i>	-	<i>Company school</i>
<i>Technique</i>	-	<i>Tempera</i>
<i>Collection</i>	-	<i>National Museum, New Delhi</i>
<i>Material</i>	-	<i>Paper (hand made)</i>

### General Description

During this period many paintings were done but very few examples are available, sometimes their artists are not known. One painting "A group of Kashmiri Artisans" has a mention. This painting is done on paper with water colour. A group consisting of eight men, two women and three children are painted in the painting. The men in the painting are engrossed in embroidering colourful shawls. The women are admiring the craftsmanship of their men. The whole group is sitting on a carpet in a house which has a wooden roof. An old man is enjoying his *hukka*. The roof and floor is leading to well defined perspective. The colours used are sober deep sepia ochre and red, and contrast strongly with the white clothes of the figure. The figure have pointed noses, heavy eye brows, deep-seated staring eyes and thin faces. Very little shading was used and modelling with stippling is frequent.

### INTEXT QUESTIONS (11.2)

1. Choose the right answer-
  - (a) Medium of this painting is
    - (i) tempera
    - (ii) Oil colour
    - (iii) Water colour
  - (b) Indian artists are inspired by
    - (i) Rajput miniature
    - (ii) Mughal
    - (iii) Western art.
  - (c) The painter of this painting used
    - (i) Stippling
    - (ii) Line shading
    - (iii) Flat colour



### 11.3 THE BIRD

<i>Title</i>	-	<i>Untitled</i>
<i>Period</i>	-	<i>Circa 19th C.A.D.</i>
<i>Name of the artist</i>	-	<i>Unknown</i>
<i>Medium</i>	-	<i>Black Ink</i>
<i>Style</i>	-	<i>Company school</i>
<i>Collection</i>	-	<i>National Museum, New Delhi.</i>

#### General Description

The technique of painting, where the picture was painted with a brush without a pencil drawing, was known as Kajli (kali) syahi, syah kalam or black ink. This untitled painting is done in black ink on paper. The unknown artist has managed to catch the sense of the surprised bird. The wing feathers are minutely depicted, like ornamental looped curtains. Earlier pictures were drawn on paper produced locally or imported from Nepal, but later, European machine-made paper was used.

---

#### INTEXT QUESTIONS (11.3)

---

1. Fill up the blanks:-

- (a) The technique of the painting is .....
  - (b) The picture is drawn on the paper imported from .....
  - (c) This painting is done in ..... style.
-

## 11.4 SUMMARY

The decline of Mughal art and Rajasthan schools of paintings occurred when the British joined the Mughal aristocracy as patrons. The Indian sympathy for birds and animals coincided with the need of the new masters for scientific studies of India's flora and fauna. The British, who had come to India as merchants during Akbar's reign became the major power. The term 'Company painting' also known as Patna school has come to be used for a special type of Indian painting which was produced for Europeans and was heavily influenced by Europeans taste. Although many different idioms of the Company style developed in different parts of India, the term covers a single phenomenon: an attempt by Indian artists to work in a mixed Indo-European style which would appeal to the Europeans who were employed by the various East India companies.

---

## 11.5 ANSWERS OF INTEXT QUESTIONS

---

- |      |                  |                 |               |
|------|------------------|-----------------|---------------|
| 11.2 | (a) Water colour | (b) Western art | (c) Stippling |
| 11.3 | (a) Kajli Syahi  | (b) Nepal       | (c) Company   |
- 

## 11.6 MODEL QUESTIONS

---

Give brief description of the following:

1. Why Company school is also known as Patna school?
  2. Why Indian artists were hired by the Europeans?
  3. Describe the subjects of Company School paintings.
  4. Describe the characteristics of Company School paintings.
- 

## 11.7 GLOSSARY:

- Stippling - Drawing by means of dots or small touches
- Engraving - the art of forming designs by cutting, corrosion by acid on the surface of metal plate for the purpose of taking impressions or print of the design.



332en12

## 12

# Pioneers of Contemporary Art Movements in India

### 12.0 INTRODUCTION

When Indians lost their war of independence in 1857, India became a British colony. At that moment, art movement succeeded in weaning away the young painters to the strong influence of British naturalism and classical western art, but it soon lost its relevance. The age-old themes derived from epics and classical literature, so popular among the Bengal School artists, did not remain relevant to the needs of a changing society. The Indian people on the one hand were reeling under the British oppression and on the other hand were trying to throw away the yoke of slavery. They were struggling to usher in an era of independence, of self-respect and self-determination in socio-economic and political spheres. The need was felt for an art form which reflected the mood of a changing society.

### 12.1 OBJECTIVES

After studying this module, learner will be able to:

- Describe the evolution of Bengal School art.
- State the name of artists, methods and material, sizes, themes and places of enlisted paintings.
- Tell the title of enlisted paintings of the period.
- Identify the art of Bengal School painting from other paintings.

While travelling into India, British brought prints of paintings from Europe. The availability of European prints provided Indian artists new modes of expression and new ways of looking at problems of naturalistic representation. This European component in Mughal painting was a lasting contribution that filtered through into the later regional schools from which Company artists were recruited. Many of the traditional artists got opportunities to see them at work. It was in this informal and un-programmed way that the Indian artists of, what has been called the Company School of painting, gained some skill in the Western type of realism. When this change was taking place arose one artist who became the legend of Indian paintings of modern era in the form of Ravi Varma (1848-1906)



*Ravana and Jatayu*

## 12.2 RAVANA AND JATAYU

<i>Title</i>	–	<i>Ravana and Jatayu</i>
<i>Artist</i>	–	<i>Raja Ravi Varma</i>
<i>Medium</i>	–	<i>Oil</i>
<i>Style</i>	–	<i>European</i>
<i>Collection</i>	–	<i>National Museum; New Delhi</i>

**General Description**

Raja Ravi Varma belonged to the Royal family of Travancore (on the south west coast of India). He painted in oil and his work, in a late Neo-classical style, has a Victorian heaviness. The staginess of his art is much clearer to us than it was to his contemporaries, who considered him the most outstanding painter in the western academic style. His painting were reproduced in oleographs and distributed widely. His painting are mostly with an epic or religious subject matter. He was not an incompetent portrait painter, his sole contribution perhaps is that he re-introduced Indian subjects as sacred national ideals and vision. An example of Raja Ravi Varma's oil paintings is *Ravana and Jatayu* based on epic Ramayan. Varma reveals here his ability to seize movement and build up a composition on the principle of dynamic balance. Jatayu is trying to free Sita from Ravana. In the act Ravana has cut the right wing of Jatayu with his sword. By covering her face Sita is avoiding to see the cruelty of *Ravana*. Upward movement of *Ravana* suggests the fleeing with *Sita*. Ravi Varma perpetuated a kind of Indian feminine type. Other paintings of Raja Ravi Varma '*Harishchandra*', '*Bhusma's Vow*', '*Hansa Damayanti*' are all good examples.

**IN-TEXT QUESTIONS (12.2)**

Fill in the blanks-

1. Ravi Varma belonged to \_\_\_\_\_ (A) Artist family (B) Royal Family (C) Poor Family.
2. Ravi Varma did painting in \_\_\_\_\_ (A) Water colour, (B) Tempera, (C) Oil.
3. \_\_\_\_\_ was the first Indian painter to paint in Oil (A) Alagiri Naidu, (B) Raja Raja Varma, (C) Ravi Varma.
4. \_\_\_\_\_ made Ravi Varma famous (A) Photograph, (B) Oleograph, (C) Lithograph.



*Radhika*



## 12.3 BENGAL SCHOOL

Abanindranath Tagore, a member of Indian Tagore family of Calcutta, wanted to develop a form of art which could be identified as Indian art and at the same time contemporary to style. His studies in the history of Japan's place in Japanese became the cause of this art movement and several ideas gradually built up the Bengal School, including such artists as Manohar Das, Kankar Das, Ash Kumar Mukherjee, Chandra and others. Several of them were appointed Principals of art schools in different parts of the country and spread the style of Abanindranath, which is known as Bengal School style of art.

In the Art Schools at Bombay (now Mumbai), Madras (now Chennai), Kolkata and Lahore which had been established by the British, the western art education used to be given in which water colour and oil paint techniques were taught in western style. For some time Abanindranath worked as a teacher in Kolkata Art School and made arrangements for teaching Indian classical art. Thus he was able to generate a great interest in the young students for the Indian Classical art. Gradually the Indian movements were deeply rooted in the Bengal School.

The characteristics and the domain of Bengal School are reflected in the historical, religious literary paintings etc. the most important characteristic of Bengal School is its colour system which is known by "wash" technique.

Bengal School could make its impression on the contemporary Indian art for a limited period because the young artists of new generation mostly started being influenced by the then prevailing social and political conditions.

## 12.4 RADHIKA

Title	- Radhika
Artist	- Abanindra Nath Tagora
Medium	- Water colour and Wash on Paper
Style	- Bengal School
Size	- 14x21 cm
Collection	- National Gallery of Modern Art, New Delhi (ACC 1861)

### General Description

The foremost pioneer of Bengal School, Sri Abanindra Nath Tagore was born on 7 August 1871. In 1905, Abanindra Nath was appointed Vice-Principal of Calcutta School of Art. Younger artists began to adopt Abanindra Nath's manner, with its tepid colour and wistful sentimentality. Abanindra Nath combined the Indian tempera - techniques with the Japanese water colour evolving a new style of painting called the wash technique. He also evolved a mystic and mellow style with diffused light background and elongated lyrical figures. Radhika is an example of Abanindra Nath style. Radha has gone to collect some water in an earthen pot from river. In a simple composition Radha is shown wearing a typical sari in Bengalee style. The figure is very natural, soothing and delicate. Tempera also became a popular medium of Bengal School painters. In his later works Abanindra Nath was influenced by calligraphist and painters from China and paint makers from Japan.

Students of Bengal School took inspiration from ancient epics classical literature; their compositions were usually based on the format of Rajput and Pahari paintings.

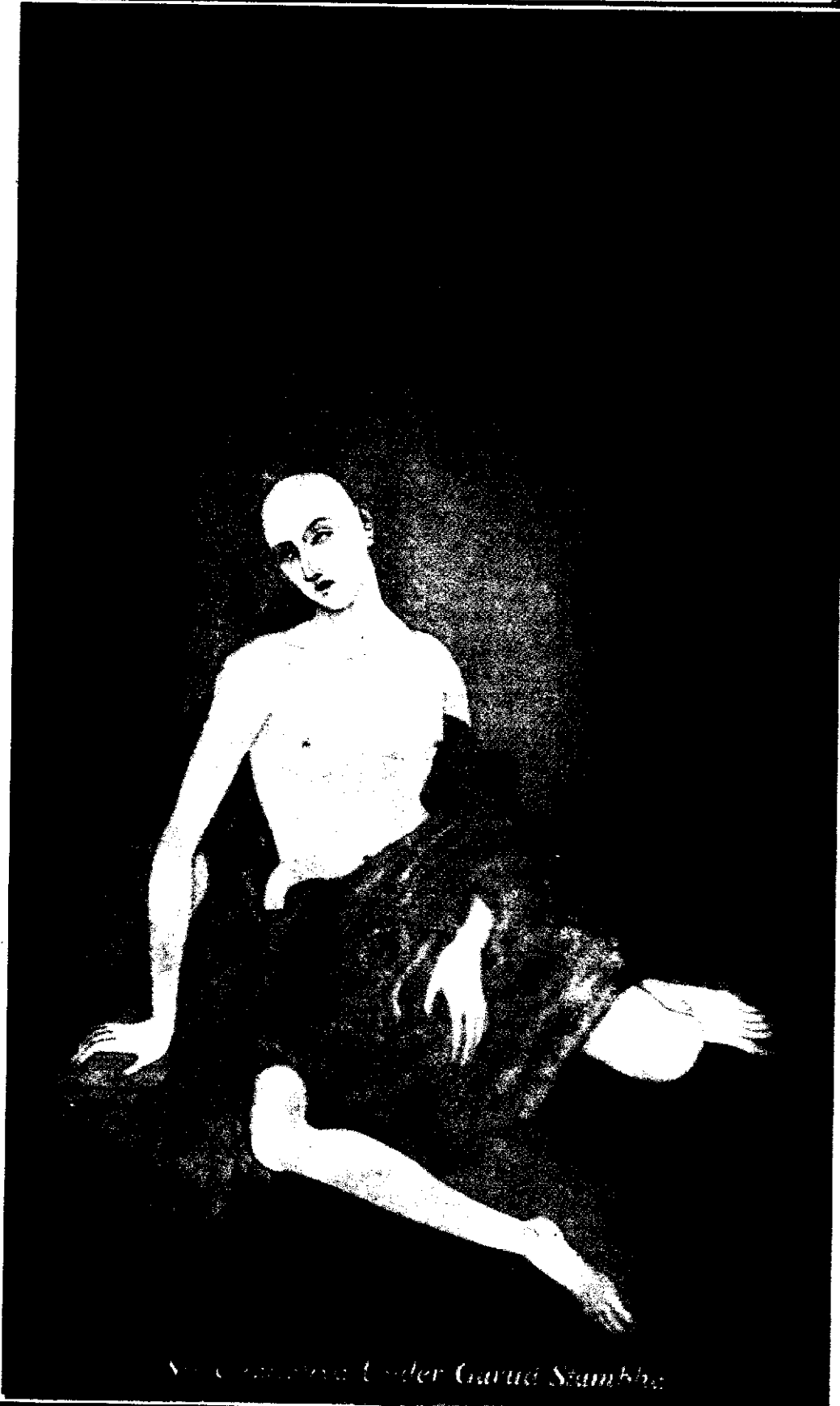

*V. C. ... Under Garud Stambha*

---

## IN-TEXT QUESTIONS (12.4)

---

Fill in the blanks:-

- (1) The new style of painting evolved by Abanindra Nath is called as \_\_\_\_\_.
  - (2) \_\_\_\_\_ is an example of Abanindra Nath Style.
  - (3) Abanindra Nath was influenced by \_\_\_\_\_ and \_\_\_\_\_ from China and paint makers of Japan.
- 

## 12.5 SRI CHAITANYA UNDER GARUD STAMBHA

<i>Title</i>	–	<i>Sri Chaitanya under Garud Stambha</i>
<i>Artist</i>	–	<i>Nandlal Bose</i>
<i>Medium</i>	–	<i>Wash and Tempera on Paper</i>
<i>Style</i>	–	<i>Bengal School</i>
<i>Size</i>	–	<i>22.8 x 40 cm</i>
<i>Collection</i>	–	<i>National Gallery of Modern Art, New Delhi (ACC 4791)</i>

### General Description

Abanindra Nath's disciple Nandlal Bose learnt at Govt. School of Art & Craft, Calcutta and extended the tradition by doing paintings in a different style. Shantiniketan flourished under Nandlal Bose. Nandlal had a great respect for the Indian tradition both in art and life. He visited Ajanta and the Bagh caves in 1920-21, carefully making studies and drawing of the murals which later reflected in his works. *Nandlal* painted *Sri Chaitanya under Garud Stambha* in mixed medium (wash & tempera). *Chaitanya* in grief is reclining against a pillar. He is supporting his body with his right hand. Part of his body is covered with a cloth. The gesture of limbs suggests depression. Longish fingers are with feminine delicacy. On the top of pillar Garud-the carrier of Lord Vishnu, is sitting. A devine light is pouring down to Chaitanya suggesting the blessings.

---

## IN-TEXT QUESTIONS (12.5)

---

Circle the correct word:-

1. Art schools were established by (A) EB Havell, (B) British, (C) Abanindra Nath
  2. Nandlal Bose followed (A) EB Habel (B) Gogonendra Nath, (C) Abanindra Nath
  3. Nandlal Bose learnt at (A) Govt. School of Art, & Craft calcutta (B) Art School of Mumbai (C) Art School of Madras.
-

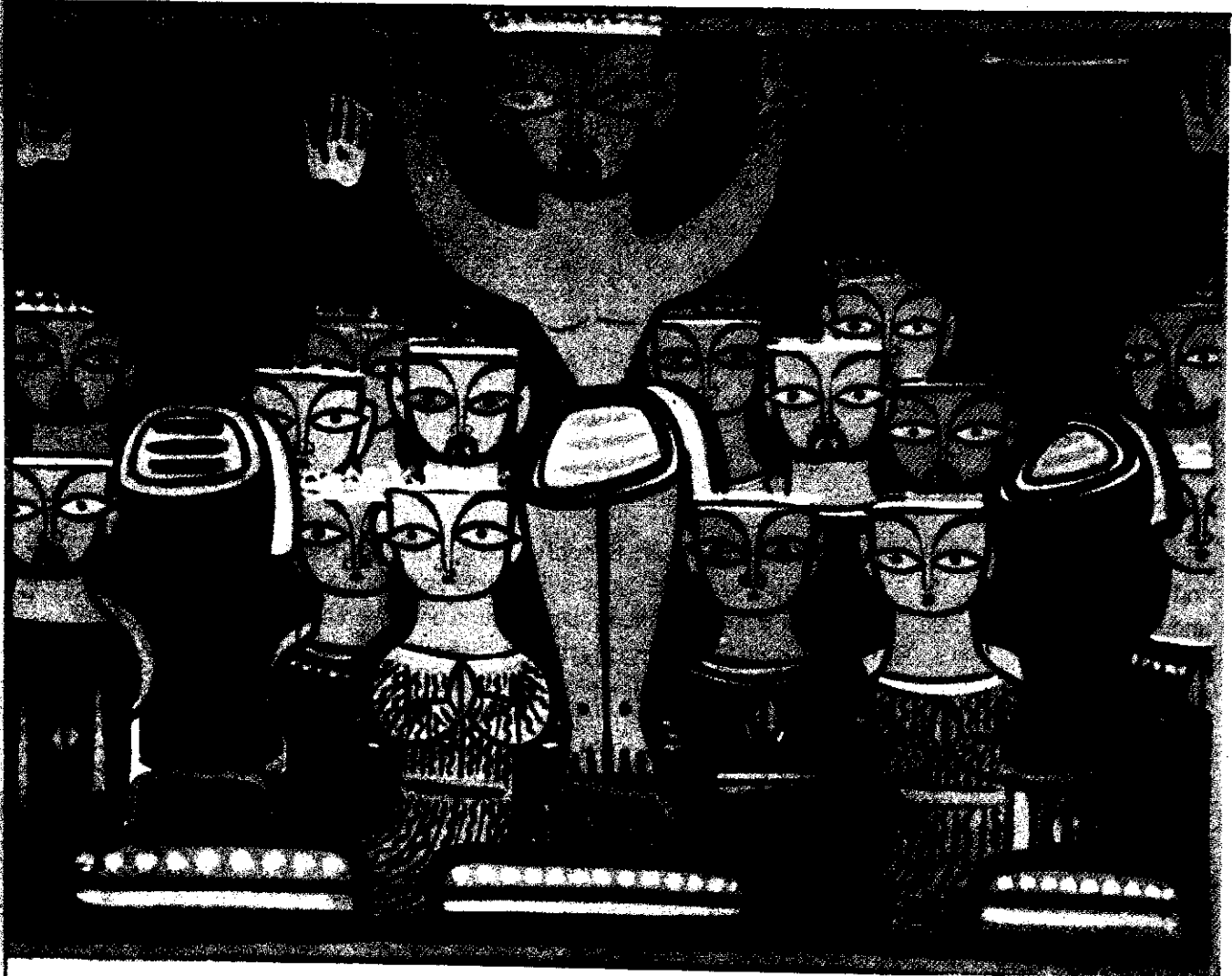

*Crucifixion*

## 12.6 CRUCIFIXION

<i>Title</i>	—	<i>Crucifixion</i>
<i>Artist</i>	—	<i>Jamini Roy</i>
<i>Medium</i>	—	<i>Tempera on cloth</i>
<i>Style</i>	—	<i>Folk Art</i>
<i>Size</i>	—	<i>88.5 x 66.5 cm</i>
<i>Collection</i>	—	<i>National Gallery of Modern Art, New Delhi (ACC 157)</i>

### General Description

Jamini Roy developed his own style rejecting both Bengal School and western style. His style is based on Bengal Folk art form. Jamini Roy was born in April 1882 at Baliatore District Bankura in Bengal. When Jamini Roy was sixteen years of age, he was sent to Kolkata (Calcutta) to study painting. Though he was trained in western techniques but instead of using western facilities he reduced to seven colours which he prepared with local earth colours crushed in tamarind glue or in the white of the egg. For the greys, he used the mud of river; for the vermilion he took from the ritual composition used by women; blue is just the simple indigo and white lime. And when he required black, it was the modest black of soot that he employed. In the preparation of his canvas he used cowdung. In his paintings he portrayed all the activities of the people. He expressed religious scenes, strange ritual dances etc. Jamini used the traditional tempera technique. His sources of inspiration were the pata-chitras of Kalighat and terracotta toys of Bankura. His paintings show a remarkable economy of lines, simplicity of drawing and solidity in his compositions. The art of Jamini Roy, however, does not limit itself to the face of India; it has sometimes searched for inspiration from outside countries. It resulted in strange portrait of Christ. Crucifixion is the resemblance with those painted in Byzantium and is an astonishing painting. This painting in tempera on paper shows the event of crucifixion of Christ. Amongst three figures, two right and left side figures are painted in dark colours thus giving the importance to the central figure. In the background a number of followers are praying with folded hands. The mood of the entire painting is grief.

---

### IN TEXT QUESTION (12.6)

---

Choose the correct word:-

1. Jamini Roy used (A) Natural colours, (B) British colours, (C) Wash Colours
2. Jamini was born in (A) April 1882, (B) June 1838. (C) July 1882
3. Jamini Roy used the traditional (A) Tempera Technique (B) Acrylic Colours (C) Oil Colours
4. The mood of Jamini Roy's Crucifixion is (A) Joy, (B) Horror (C) Grief.

---

### 12.7 SUMMARY

After the negligence of Indian art by the later Mughals, the new rulers emerged as artists. Ravi Varma born in a princely family of Kilimanoor near Travancore. Raja Ravi Varma painted in oil and in a style that was akin to academic realism. Both means and methods were European. He was popularized through the oleographs issued by his press established in Bombay.

The greatest contribution of the Bengal School was restoring the pride of educated people in their rich cultural heritage and weaning them away from thoughtless imitation of British art and western cultural influences. Thus the Bengal School succeeded in bringing the painters, sculptors, poets and musicians into the mainstream of the Indian Art.

The painters, who started their career under the guidance of masters of Bengal School, were soon exposed to the art of Impressionists and the Expressionists of Europe. This exposure opened up new dimensions of pictorial arts to them. They started experimenting with new mediums, themes and techniques. Their paintings started reflecting a new sense of freedom and a great individual thrust. Artists rejected the romanticism and lyricism of Bengal School and moved over to working on themes which were relevant to the changing socio-political conditions of the country. These painters and sculptors are called the radicals of Bengal School.

---

**12.8 MODEL QUESTIONS**

---

Give brief description of the following:

1. What was the purpose of East India Company to recruit the Indian artists?
2. Describe the themes of Ravi Varma's paintings?
3. Write on Abanindranath's Painting 'Radhika'.
4. Describe the painting 'Chaitanya under Guard Stambha'.

---

**12.9 ANSWERS OF IN-TEXT QUESTIONS:**

---

12.2 : 1B, 2C, 3C, 4B

12.4 : (1) Wash-techniques, (2) Radhika, (3) Calligraphist, painters.

12.5 : 1C, 2C, 3A

12.6 : 1A, 2A, 3A, 4C



# Contemporary Art of India

## 13.0 INTRODUCTION

After the decline of Mughal and Pahari paintings and traditional plastic art, there was a vacuum in the field of art in India during the 19<sup>th</sup> C. Government schools of art were founded in the presidency towns to train Indian art students, mainly in European style. Raja Ravi Verma, a self taught painter of South, popularized mythological theme with very realistic style of the west. Abanindranath Tagore from Bengal, developed an indigenous style of painting and built up the Bengal school, along with his worthy disciples like Nandalal Bose, Benode-Behari, Sarada Ukil and others. When this movement was spreading all over India, Amrita Shergil, trained in Paris, appeared in the art scene of India. She combined the western technique with Indian spirit which appealed the young generation of painters. The famous poet Rabindranath Tagore, started painting at the age of 67 and brought the expressionist style in his painting. In the same period, Jamini Roy, rediscovered the beauty of Folk art and redefined it into modern art.

The above-mentioned pioneers of contemporary art were followed by many young artists with different view towards life. The painting of "Calcutta group" of Bengal and "Progressive artist group" of Bombay contributed substantially in the development of contemporary Indian art.

## 13.1 OBJECTIVES

After studying this lesson, the learner should be able to:

- explain the evolution of Modern Art movement;
- identify the works of enlisted Modern (contemporary) artists and sculptors;
- state the name of methods and materials, size, theme and place of enlisted paintings and sculptures;
- tell the title of the enlisted paintings and sculptures.



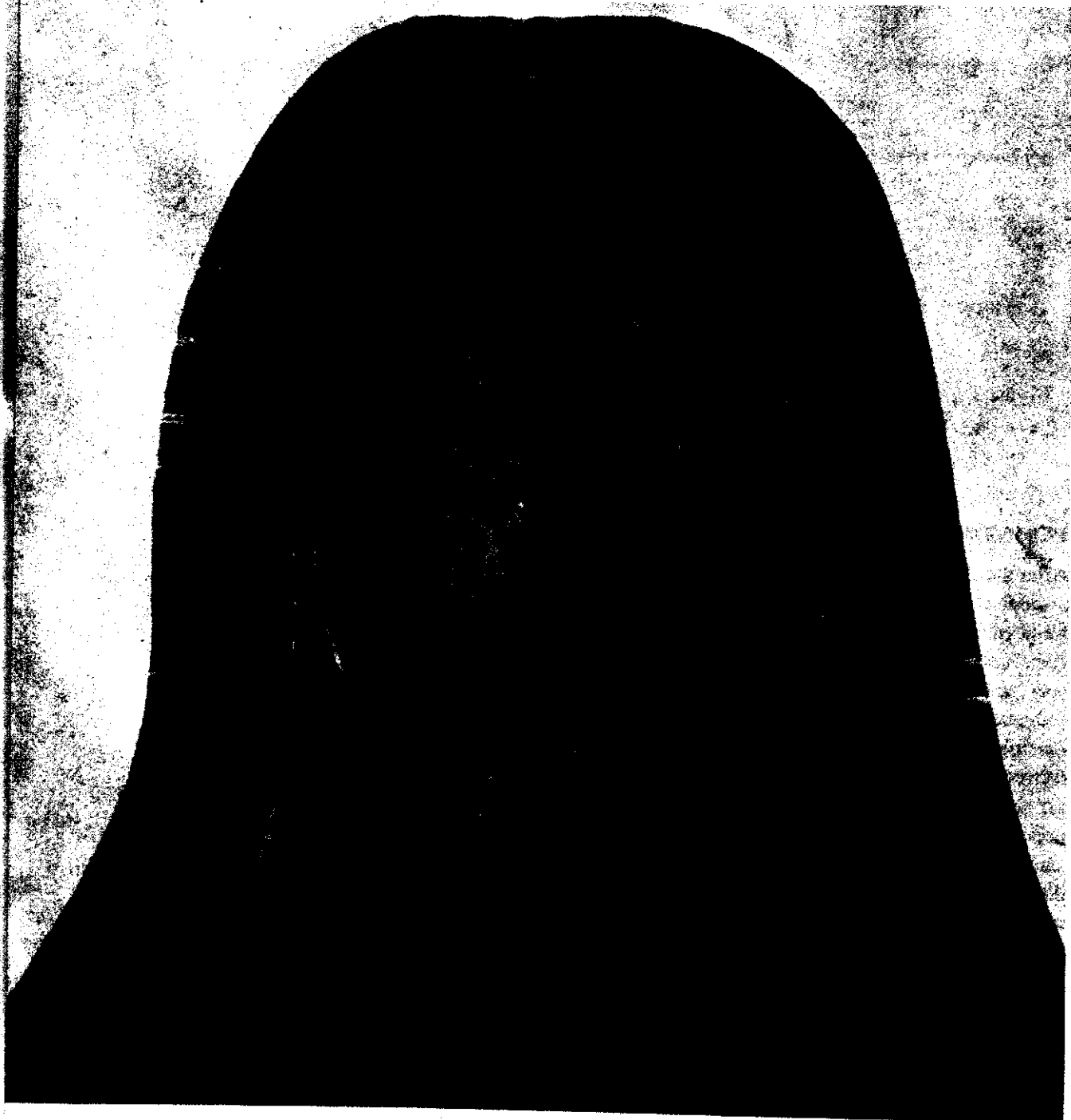

*Woman Face*

---

## 13.2 WOMAN FACE

<i>Title</i>	–	<i>Woman Face</i>
<i>Artist</i>	–	<i>Rabindra Nath Tagore</i>
<i>Period</i>	–	<i>1937</i>
<i>Collection</i>	–	<i>National Gallery of Modern Art, New Delhi (ACC 1241)</i>
<i>Size</i>	–	<i>50.5 x 53cm</i>
<i>Medium</i>	–	<i>Ink &amp; Brush on Paper</i>

### General Description

Rabindra Nath Tagore set up 'KALA BHAWAN' in Santiniketan and brought Abanindra Nath Tagore, Nandalal Bose and others. Though a contemporary of Bengal School painters, he did not look for inspiration from the classical Indian Art or the romanticism of Indian Miniatures. His drawings and head studies seem to be from sub-conscious mind. Rabindra Nath's drawings and colour balances are simple. He used subdued and dark tones of colours. In this painting (woman face) he used light wash of pink and brown ink. The woman's head is covered with her 'saree'. Her lips are drawn in such a way as if she is about to whisper something.

The face of the woman had been rendered in soft, light washes of ink showing pathos and tenderness.

---

### INTEXT QUESTIONS (13.2)

---

Fill up the blanks

- (a) Rabindranath Tagore was a \_\_\_\_\_ of Bengal school.
  - (b) In his paintings he used \_\_\_\_\_ and brown ink.
  - (c) His drawings are from \_\_\_\_\_ mind.
-



*Adornment of Bride*

### 13.3 ADORNMENT OF BRIDE

<i>Title</i>	:	<i>Adornment of Bride</i>
<i>Artist</i>	:	<i>Amrita Shergil</i>
<i>Period</i>	:	<i>1937</i>
<i>Collection</i>	:	<i>National Gallery of Modern Art, New Delhi</i>
<i>Size</i>	:	<i>144.5x86cm</i>
<i>Medium</i>	:	<i>Oil on Canvas</i>

#### General Description

“ADORNMENT OF BRIDE” is a composition with five figures. The colour contrasts of the bodies of the maid and the bride binds the group. The mauve, pinks, greens, whites and browns against her favourite pale green background, makes the painting well balanced and harmonious.

Her aim was always to create an art connected with Soul. The rhythm of the painting ‘Adornment of bride’ was achieved by the use of hand gestures. On the foreground there are two earthen ‘gharas’. One girl is dressing the hairs of the bride and the other girl is holding a pot. The bride’s both palms are painted with red colour which is commonly used during marriage ceremony in India. Most of her compositions are based on simplified forms and colours. She was influenced by Ajanta murals and Rajput miniature painting. She combined the Indian influence with her European technique and style of painting.

---

#### INTEXT QUESTIONS (13.3)

---

##### FILL IN THE BLANKS:

- (a) Amrita Shergil used \_\_\_\_\_ medium in her painting.
  - (b) Her most of the paintings are \_\_\_\_\_ composition.
  - (c) Bride’s both palms are painted with \_\_\_\_\_ colour.
-



*Santhal Family*

## 13.4 SANTHAL FAMILY

<i>Title of the Sculpture</i>	–	<i>Santhal Family</i>
<i>Sculptor</i>	–	<i>Ram Kinker Vaij</i>
<i>Period</i>	–	<i>1938</i>
<i>Collection</i>	–	<i>Shantiniketan, West Bengal</i>
<i>Size</i>	–	<i>290x200x315 cm Height</i>
<i>Medium</i>	–	<i>Concrete</i>

**General Description**

Ramkinkar studied at Visva-Bharati in Shantiniketan and was closely associated with Nandalal Bose and Binod Bihari Mookherjee. He is one of the best known sculptors and painters of India. One of his famous sculptures *Yaksha & Yakshini* is installed at The Reserve Bank of India, New Delhi. His approach towards the handling of the subject and material was bold. He generally used concrete which is easily available is create a rough texture. *Santhal Family* is made of the same medium. The composition comprises of a man, a woman, a child and a dog. They are moving towards a new destination with full of hope and aspiration, leaving behind their home in search of work.

**INTEXT QUESTIONS (13.4)**

Choose the right Answer

- (a) Ramkinkars '*Santhal Family*' is made of
- Sand Stone
  - Concrete
  - Bronze.
- (b) The sculptures on the doorway of Reserve Bank of India are created by
- D.P. Roy Chawdhuri
  - Ramkinkar
  - Dhanraj Bhagat.
- (c) He was a student of
- Visva Bharati
  - Delhi College of Art
  - J.J.School of Art.

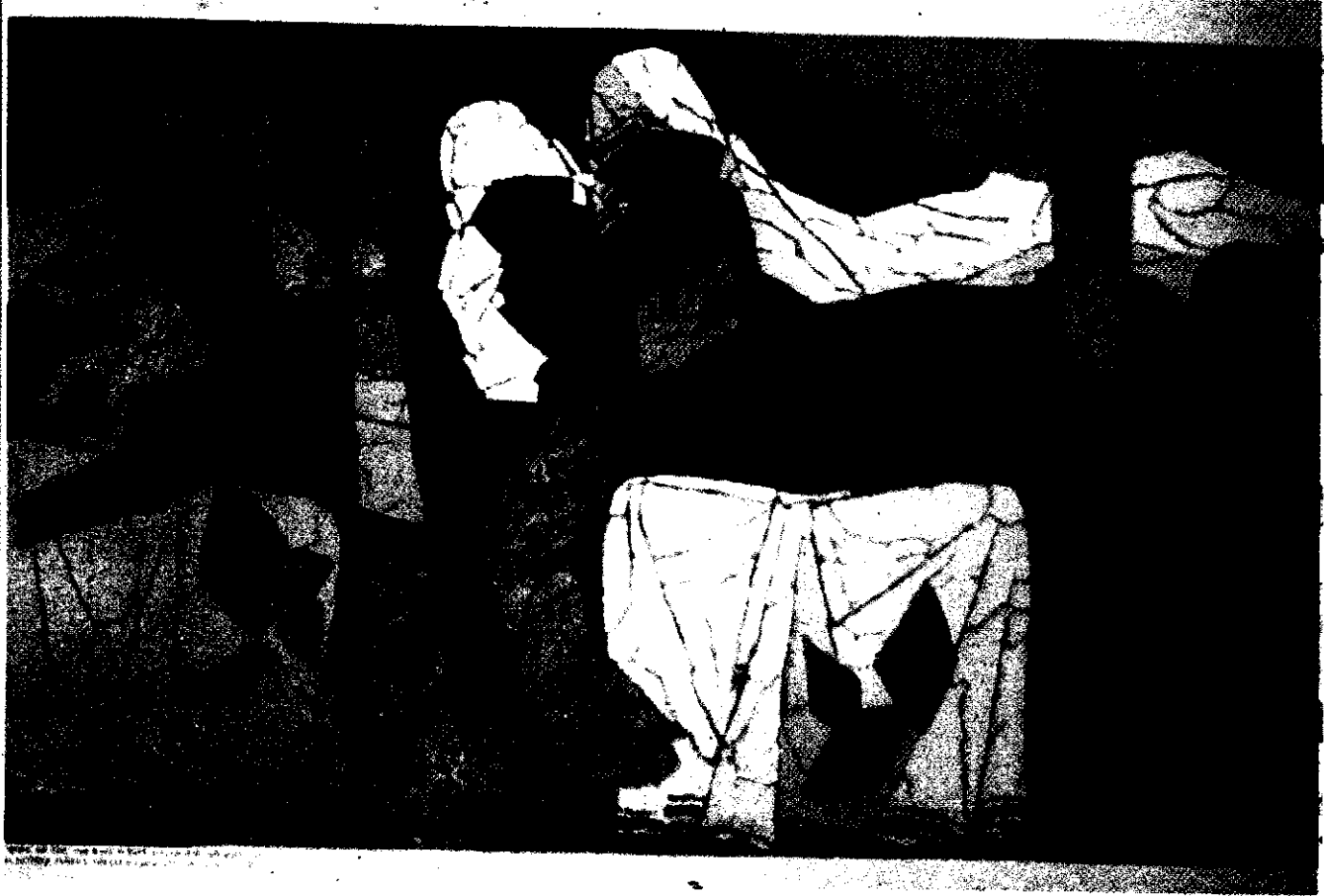

*Mother Teresa*

**14.5 MOTHER TERESA**

<i>Title of the Painting</i>	–	<i>Mother Teresa</i>
<i>Artist</i>	–	<i>Maqbul Fida Hussain</i>
<i>Period</i>	–	<i>1988</i>
<i>Collection</i>	–	<i>National Gallery of Modern Art, New Delhi</i>
<i>Size</i>	–	<i>233X128cm</i>
<i>Medium</i>	–	<i>Oil on Canvas</i>

**General Description**

Hussain revealed the contradictions and inconsistencies of our society pictorially by juxtaposition of masses, colours and symbols. His paintings are synthesis of mythology and modern life. He started his career as a banner painter and that gave him confidence to handle huge spaces of large canvases.

He developed a simple style using strong lines and bold colours after going through rigorous self-discipline in his works. He is essentially an expressive and symbolic painter.

Mother Teresa, who lived in Kolkata and served the poor and the homeless is a world known personality. This inspired Hussain to paint series of paintings on Mother Teresa.

In the painting, Hussain has not shown her face, but left that space dark. The *Saree* with blue border identifies unmistakably Mother Teresa. It is a horizontal composition and divided into three parts by two uneven vertical pillars. The colours of the pillars are yellow and light brown. In the left, Mother is taking care of a child on her lap. In the center there are two Mother-like forms. They are faceless. One raised hand shows the gesture of blessings. The white veil of one of them is extended towards the right. The red reclining figure is covering the whole space from left to the right. A devotee is touching the hand of the figure. The dominant colours of the painting are dark purple, white, red, yellow and green.

**INTEXT QUESTIONS (13.5)**

Fill up the blanks–

- Hussain's painting is synthesis of \_\_\_\_\_ and \_\_\_\_\_.
- Mother Teresa lived in \_\_\_\_\_.
- Hussain started his carrier as a \_\_\_\_\_ painter.





*Thorn Prick*

### 13.6 THORN PRICK

<i>Title</i>	–	<i>Thorn Prick</i>
<i>Artist</i>	–	<i>N.S. Bendre</i>
<i>Period</i>	–	<i>1955</i>
<i>Collection</i>	–	<i>National Gallery of Modern Art, New Delhi.</i>
<i>Size</i>	–	<i>119.3x168 cm</i>
<i>Medium</i>	–	<i>Oil on Board</i>

#### General Description

N.S.BENDRE studied at School of Art, Indore in western style. Later he headed the Fine Art Faculty of M.S.Univeristy Baroda and produced generations of Artists. He is undoubtedly a versatile painter and gradually cultivated his own style of painting. He is descriptive at one side and representative on the other side. His works are naturalistic as well as romantic.

The painting 'THORN PRICK' is a vertical composition which reminds certain compositions of Ajanta paintings. In the centre a woman is pricking a thorn with her right hand holding a branch of a tree with her left hand. There are triangular shaped hills and trees with a few branches and leaves. The painting is based on cubist style. He used dark and contrasting colours - such as blue, brown, red and yellow.

---

#### INTEXT QUESTIONS (13.6)

---

Fill up the blanks–

- Bendre was head of the Department of painting in \_\_\_\_\_.
  - His works are \_\_\_\_\_ as well as \_\_\_\_\_.
  - The painting is based on \_\_\_\_\_ style.
-

### 13.7 SUMMARY

After the contributions in the development of contemporary Indian art by the pioneers like Raja Ravi Verma, Abanindranath, Rabindranath, Amrita Shergil and Jamini Roy, Indian art was constantly nourished by artists like N.S. Bendre, F.N. Souza, M.F. Hussain, S.H. Raja, Ganesh Ryne Bikash Bhattacharya, Satish Gujral and others. In the South we have artists like Paniker, Srinivasulu and the Cholamandala group of artists.

---

### 13.8 MODEL QUESTIONS:

---

1. Write a brief description of the painting "WOMAN FACE"?
2. What type of materials 'RAM KINKAR' used for the sculpture?
3. Describe the composition of the painting 'ADORNMENT OF BRIDE'?
4. Write a paragraph on Hussain's style of painting?

---

### 13.9 ANSWER OF THE INTEXT QUESTIONS

---

- 13.2 (a) Contemporary (b) Light wash of pink (c) Subconscious.  
13.3 (a) Oil colour (b) Simplified forms (c) Red  
13.4 (a) Concrete (b) Ramkinkar (c) Visva Bharati  
13.5 (a) Mythology and Modern life (b) Kolkata (c) Banner  
13.6 (a) M.S. University, Baroda (b) Naturalistic, Romantic (c) Cubist

### 13.10 GLOSSARY

1. AFFILIATION - Attachment.
2. LYRICISM - Using emotional poetical language.
3. SYMBOLS - Not Literal.
4. ASPIRATION - Desire, Ambition.
5. CONTRADICION - Opposite
6. INCONSISTENCIES - Not logical
7. JUXTAPOSITION - Put side by side.
8. DOMINANT - Commanding influence.
9. RIGOROUS - Hard work.
10. MINIATURE - Small details
11. VERSATILE - Using different styles in subjects.
12. CONTRAST - Opposite
13. SCRIBBLE - Draw hurriedly or carelessly.



332en14

# 14

## Folk Paintings

### 14.0 INTRODUCTION

Art comes spontaneously from the mind to communicate to others. Expression through art is an inherent quality of human being. Folk art, in the same way, springs unself-consciously, at a grass roots level, from people's most fundamental life experience. These folk artists are ordinary people and use very simple method and material. They make use of locally available materials and prepare their own colours and brushes. Twigs or bamboo sticks are used as brush for fine lines. A piece of cloth or cotton is wrapped on the tips of the twig to draw broad lines.

Colours are made from vegetation and locally available minerals. For example, orange colour is made from Harsingar (हरसिंगार) flower. These flowers are dried in the sun and then boiled to extract the colour. Gum is added to it as binder. Red colour is extracted from *chokander* (beet roots) and green from 'Orhud' (ओड़हुद) flower. The flowers are dried and mixed with lemon, alum and gum before it is boiled. For black colour, rusted iron is put in the molasses and is kept for ten days. The molasses turns black after it is boiled. Cobalt blue comes from *jamun* (black berry) fruits and golden colour from the skin of 'Anar' (Pome grenate) fruit after adding Alum with it. This mixture is to be boiled for 48 hours. Haldi (Turmeric) supplies yellow colour.

### 14.1 OBJECTIVES

After studying this lesson the learners should be able to:

- describe distinctly the regional style of enlisted folk paintings.
- mention the method and materials used in the making of the arts.
- differentiate the identifying characteristics of the enlisted paintings.
- identify the area famous for the listed folk painting.

Now let us discuss some important forms of Indian folk art.



*Kalighat Painting (Bengal)*

## 14.2 KALIGHAT PAINTING (WEST BENGAL)

Kalighat paintings are painted by image-makers (Potua) of a locality of the same name in Kolkata. The enlisted painting is a good example in which an aristocrat is getting his ear cleaned by his servant. The distinction of their social status has been marked by the costumes and dresses.

The painting is characterized by a flat background and predominant use of colours like black, red and yellow. Figures are roundish in treatment and skin is left white. Use of light and shade to bring modeling is a noticeable element of Kalighat painting. It seems that Kalighat painters were fascinated with jewellery and ornaments. The big ear rings with pearls are interesting to note. Linearity is another characteristic of these folk forms.

---

### INTEXT QUESTIONS (14.2)

---

Fill up the blanks

- (a) Kalighat painting belongs to \_\_\_\_\_ state.
  - (b) The painting is characterized by \_\_\_\_\_ background.
  - (c) Predominant colours are \_\_\_\_\_, \_\_\_\_\_, \_\_\_\_\_.
  - (d) The big \_\_\_\_\_ with pearls are interesting to note.
  - (e) An aristocrat is getting his \_\_\_\_\_ cleaned by his \_\_\_\_\_.
-



*Kalamkari*  
*(Andhra Pradesh)*

### 14.3 KALAMKARI (ANDHRA PRADESH)

In Andhra Pradesh, both the Masulipatnam and Sri kalahasti villages are recognized as major centres for *Kalamkari* paintings. *Kalamkari* is done on cloth in batik painting and printing technique. A pen like hollow instruments is used to hold wax. So it is called *Kalam* (Pen) *Kari*. Blocks are used to print the design on the cloth. Both for dying and printing, vegetables colours are used.

The enlisted painting "Tree of Life" is a beautiful example of *Kalamkari* style. The design consists of traditional Indian motifs of flower on the stylized spread of branches and leaves. Few birds, including two peacocks, are part of this motif.

---

#### INTEXT QUESTIONS (14.3)

---

Fill up the blanks

1. Major centers of *Kalamkari* are \_\_\_\_\_, \_\_\_\_\_.
  2. *Kalamkari* is done on \_\_\_\_\_.
  3. Both \_\_\_\_\_ and \_\_\_\_\_ technique and used in *Kalamkari*.
  4. For dying and printing \_\_\_\_\_ colours are used.
-



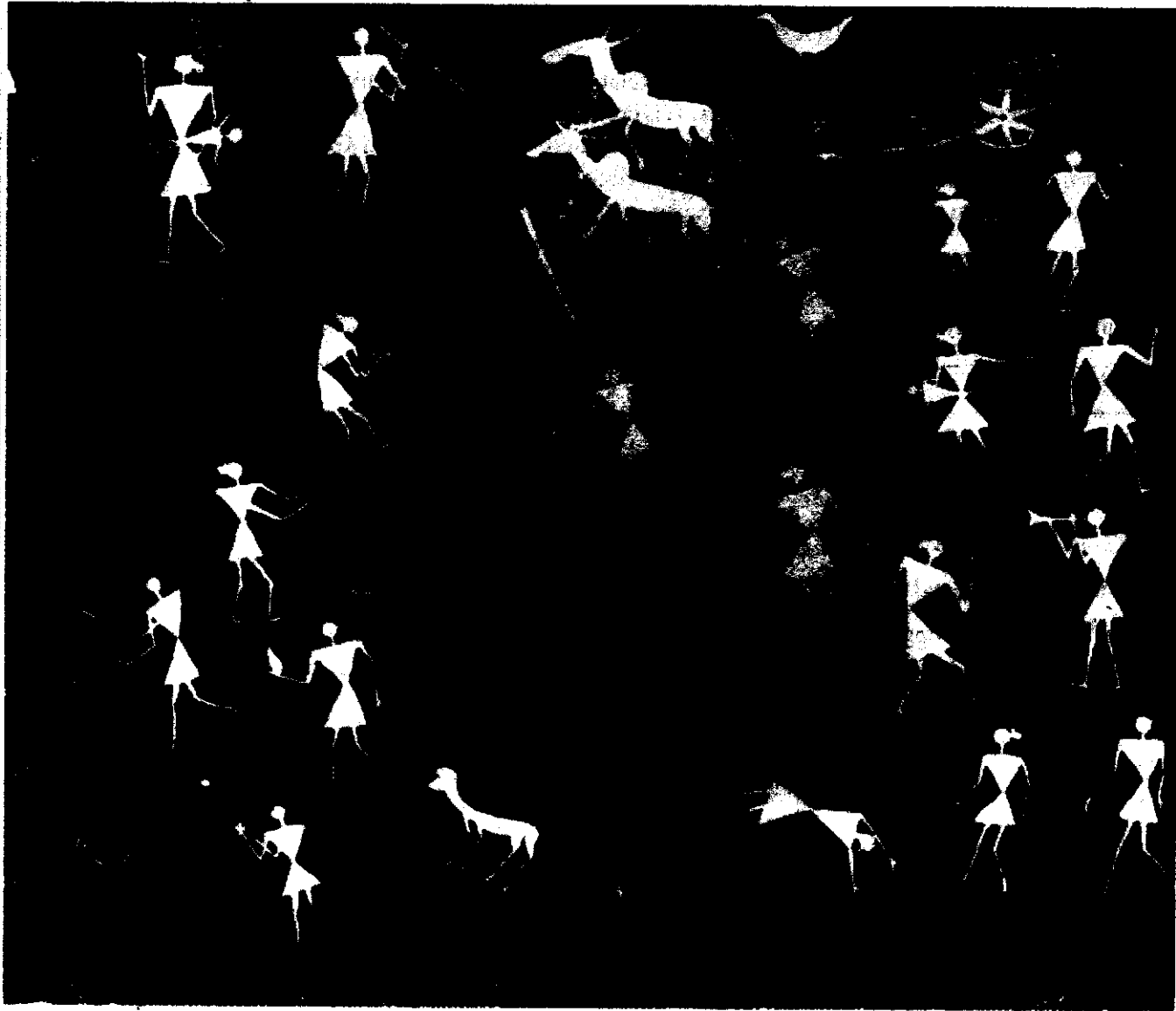

*Warli (Maharashtra)*

#### 14.4 WARLI (MAHARASHTRA)

*Warli* paintings are done by the Warli tribe of Thane district of Maharashtra. It has become well known internationally due to its famous painter *Jivya Soma Mase*.

This is one of the beautiful paintings of *Jivya Soma Mase*, which shows the everyday life of the *warlis*. Human figures are simplified into triangles and few straight lines. In spite of these simplifications, emotions are expressed in a superb way. The painting is more a statement of human and nature relationship than religious sentiments. The forms are generally drawn in white on a flat coloured background.

The picture shows some human figures and animals like monkey and snakes. The snakes are being fed by these persons.

---

#### INTEXT QUESTIONS (14.4)

---

Write the answers of the following

- (a) Name the animals, those are shown in this painting.
  - (b) How the human figures are drawn?
  - (c) Write the name of the folk painter of this picture.
  - (d) Which colour is mainly used in this painting?
-



## 14.5 PHAD (RAJASTHAN)

*Phad* is one of the famous folk paintings style of Rajasthan, which generally depicts the royal and secular themes. These paintings are narrative in nature and are painted on flat ground. This enlited picture is only a part of a panel, which shows Rajasthani men and women are engaged in various types of work. The whole panel is divided into some segments to describe different activities of social life of various people like, soldiers, worshippers, horse riders, and royal attendants on elephant and camels. In spite of multiple formats in the composition, a unity is achieved by the painter which binds all elements into one.

All the colours like red, yellow, green, black are very warm and decorative. The picture is full of local characteristics. The male members wear typical Rajasthani costumes like turban, belt, and long dress, while the females are in *Choli-lehenga* and *Dopatta*. Both men and women are decked in ornaments. "*Borla*", a kind of forehead ornaments for Rajasthani women, is also not missed.

Human figures are drawn in a very simple manner, though appear to be short. Lines are fluent and of equal thickness. "*Jhaokhas*" or covered balcony in the painting gives a Rajasthani character to the picture. The animals like, horse, elephant and specially camels are painted with charm and ornaments.

---

### INTEXT QUESTIONS (14.5)

---

Fill up the blanks :

- (a) The picture shows men and women are \_\_\_\_\_ work.
  - (b) All the colours like \_\_\_\_\_, \_\_\_\_\_, \_\_\_\_\_ and decorative.
  - (c) The male members wear \_\_\_\_\_, \_\_\_\_\_ dress.
  - (d) The animals are painted \_\_\_\_\_.
-



*Madhuvani (Mithila, Bihar)*

## 14.6 MADHUVANI (MITHILA, BIHAR)

Woman folks of Mithila paint the walls, floors and courtyard of their home during different festivals.

The enlisted picture depicts the diety of water. She is standing on an imaginary animal, floating on water (Jaladevi). The diety is with four arms, two of these arms are with lotus flowers, and one hand holds disc (*chakra*) and the other one holds a conchshell (*Shankha*). The background is totally covered with flower and leaf motifs. Forms are defined with two parallel outlines, which is a typical characteristic of *Madhuvani* paintings. Space between the two outlines remains white, and emphasises the brightly colour planes of the picture. Red, yellow and blue has been harmoniously used in this picture. Big eyes and long chin are special features of this painting style.

---

### INTEXT QUESTIONS (14.6)

---

Write the answers of the following

- (a) Name the diety of this picture?
  - (b) What does she hold in her hands?
  - (c) Describe the background of the painting.
  - (d) What is the colour of her veil?
-

### 14.7 SUMMARY

Indian states have a long tradition of folk art in different media. Folk art is a traditional art. Objects and decoration are made in a traditional fashion by craftsmen without formal training. A vast country like India have different tendencies in social and religious life. Almost each district of each state in India developed its individuality in art and craft. Folk artists decorate their home with painting. In recent times, these artists are painting on papers.

### 14.8 MODEL QUESTIONS

1. Write a note on *Madhuvani* Painting.
2. Describe the *Kalighat* Painting.
3. What is *Warli* Painting, explain very briefly.

### 14.9 ANSWERS OF INTEXT QUESTIONS

- 14.2 (a) W. Bengal (b) Flat (c) Red, black, yellow  
(d) Ear rings (e) Ear, Servant.

14.3 (1) Masuli Patnam, Sri Kalahasti; (2) Cloth; (3) Painting, printing; (4) Vegetable.

- 14.4 (a) Snake and monkey (b) Triangles and few straight lines  
(c) Jivya Soma Mase (d) White

- 14.5 (a) engaged in various types of work.  
(b) Red, yellow, green, black etc. are very warm.  
(c) Typical Rajasthani costumes like turban, belt and long.  
(d) Charm and ornaments.

- 14.6 (a) Jaladevi (b) Lotus, disc and Conch Shell  
(c) Filled with flower, leaf and fruit (d) Red

### 14.10 GLOSSARY

**Binder** - The gum binds the pigments of colour.

**Image maker** - Maker of different images of Gods and Goddesses like, *Durga, Kali, Lakshmi* etc. in clay, which are worshiped by devotees.

**Aristocrat** - Raja, Maharaja and land lords.

**Linearity** - mainly done in lines.

**Secular theme** - life of common people.

**Formats** - shape and size

**Choli-lehenga** - Blouse and skirt

**Dopatta** - Veil.



332en01 pm

# 1

## Object Drawing

### 1 INTRODUCTION

The art of the object drawing is the rediscovery and celebration of the familiar world. Subject matter is all around us—a tumbler, a cup, a book or different kinds of fruits and vegetables. We learn to know about the objects and environment through the practice of object drawing. It is human nature to imitate. Painters try to get the exactness of every natural and man-made object in their work. If a learner wishes to develop the skill by which objects are represented, naturalistically or accurately, he must begin by describing the three-dimensional form, then developing textures, colours, light and shade, and proper composition.

#### 1.1 OBJECTIVES

After studying and practicing this lesson, the learner should be able to:

- draw the object proportionately;
- differentiate between natural and geometrical forms;
- distinguish between light and dark objects;
- arrange and draw the given objects within the space using perspective while considering the background and foreground.



## 1.2 GENERAL DESCRIPTION

### Perspective

Knowledge of perspective and proportion is essential in any object and naturalistic drawing. To understand perspective, take several of the same object and arrange them in a row, (look at a railway and fishplates) and you will notice the row at the back is higher than the one in the front. The two railway lines also appear to meet in the far distance, though these are parallel. All these are the illusions of perspective.

Perspective can be divided in three parts:

1. Linear Perspective
2. Circular Perspective
3. Colour Perspective

#### 1.2.i. Linear perspective

Linear perspective is generally used in still life drawing. It is a perspective system in which forms get smaller as they recede in space, recording parallel lines converge at a vanishing point. Beside the varied contours and cross contour lines, on any other lines and live patterns have been developed to create shading effects. Shading defines the light and give the object solidity in the drawing darkness, width, and direction of line indicate, the depth of the space in drawing. Colours also help to bring depth in space. Some colours have inherent quality to project and to recede. A painter uses these colours according to his requirement.

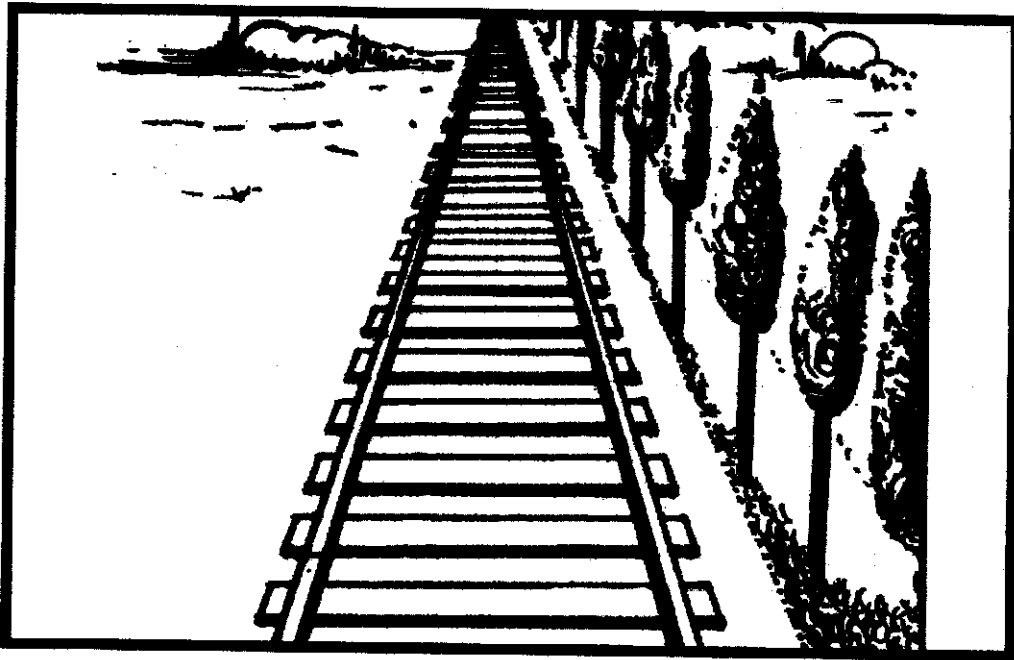
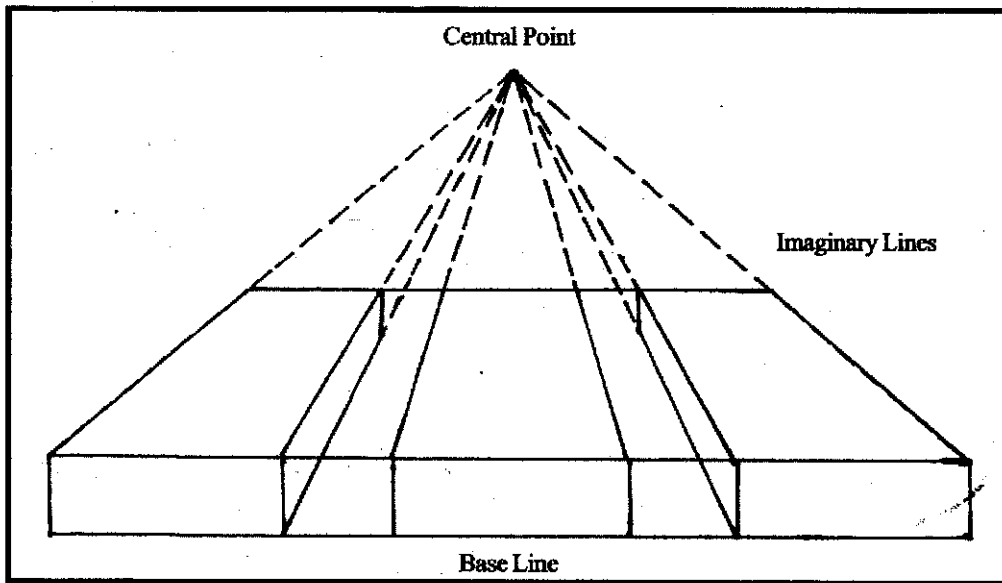
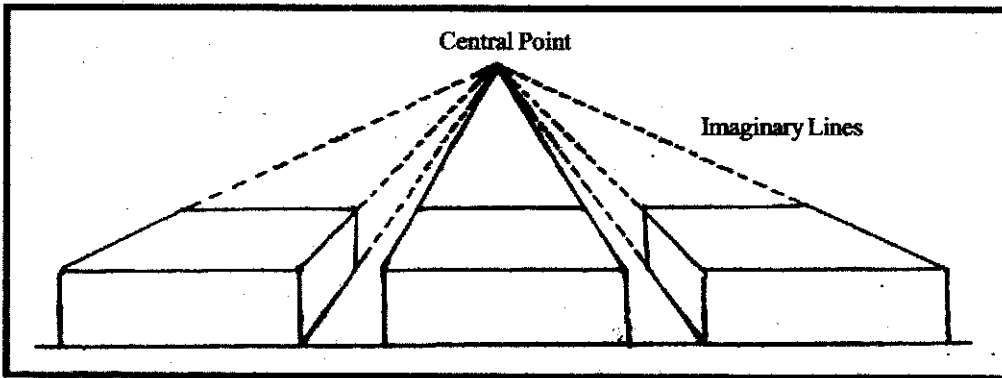

Fig. 1.1



*Fig. 1.2*



*Fig. 1.3*

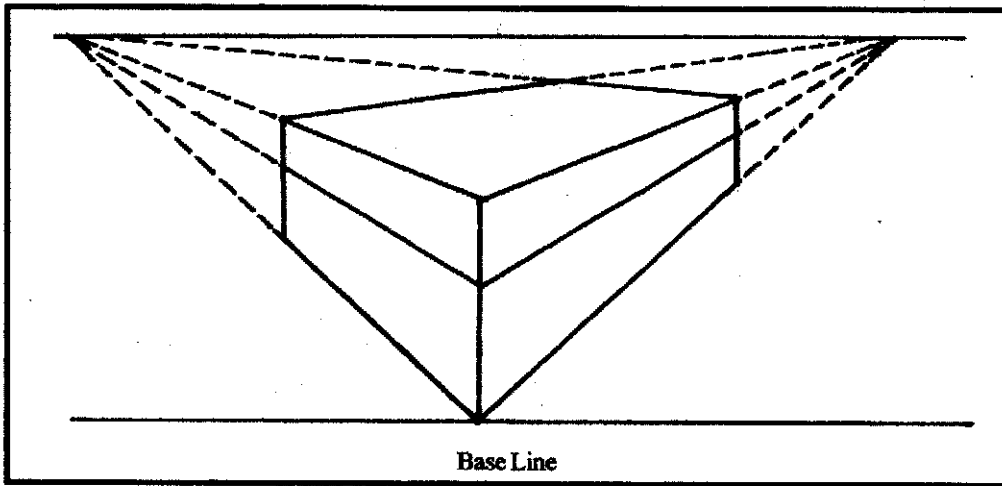

*Fig. 1.4*

### 1.2.ii Circular Perspective

It involves drawing a circle in perspective. A circle or any circular object would appear as a perfect circle when it is seen from the top view (bird's eye view) (Fig No 1.6A). It appears more and more ellipse (Fig No 1.6B) as the angle of view moves to the eye level. Ultimately the far side arc of the ellipse meets the front one and turn into a straight line (Fig No 1.6C).

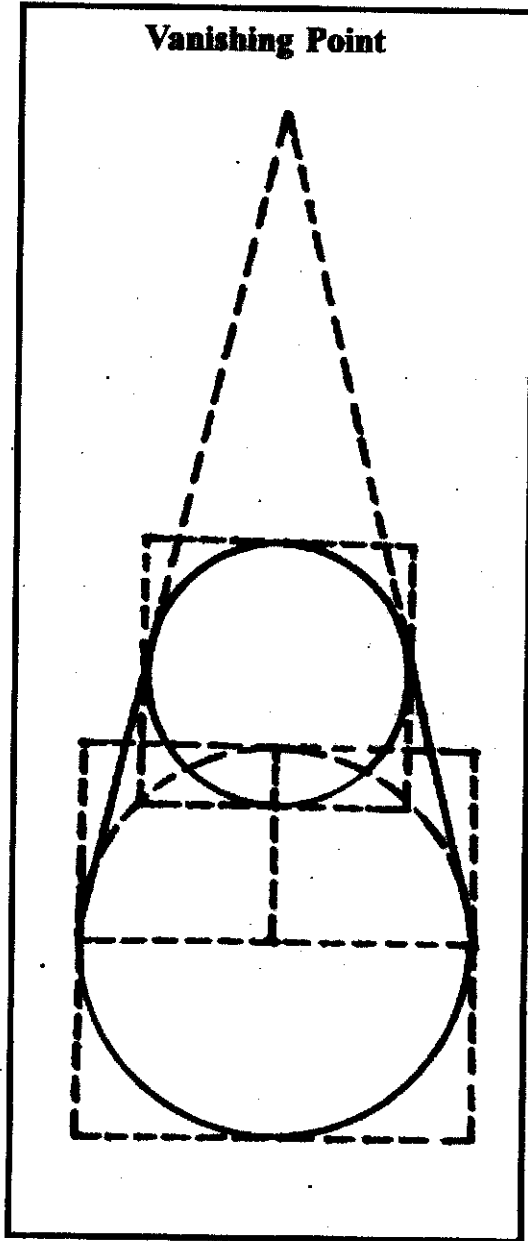

Fig. 1.5

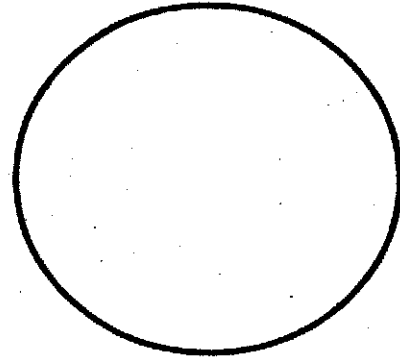

Fig. 1.6A

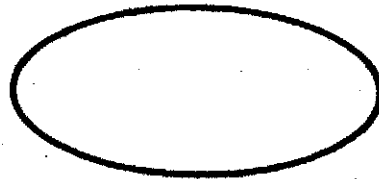

Fig. 1.6B



Fig. 1.6C

### 1.2.iii. Colour Perspective

It is very important to create an illusion of solidity of the object in an object drawing. Either a round object or a square cube should be three dimensional in appearance. All objects rest on space. The depth of these space could be achieved by the use of bright and warm colours in the foreground and softer blurring colour in the background. Define the shaded part of the object and mark the lighted part carefully. Use bright colours (yellow, white, red, etc.) for the lighted portion and darker shade (Brown, gray, blue etc.) for the shadows. (Fig. No. 1.7)

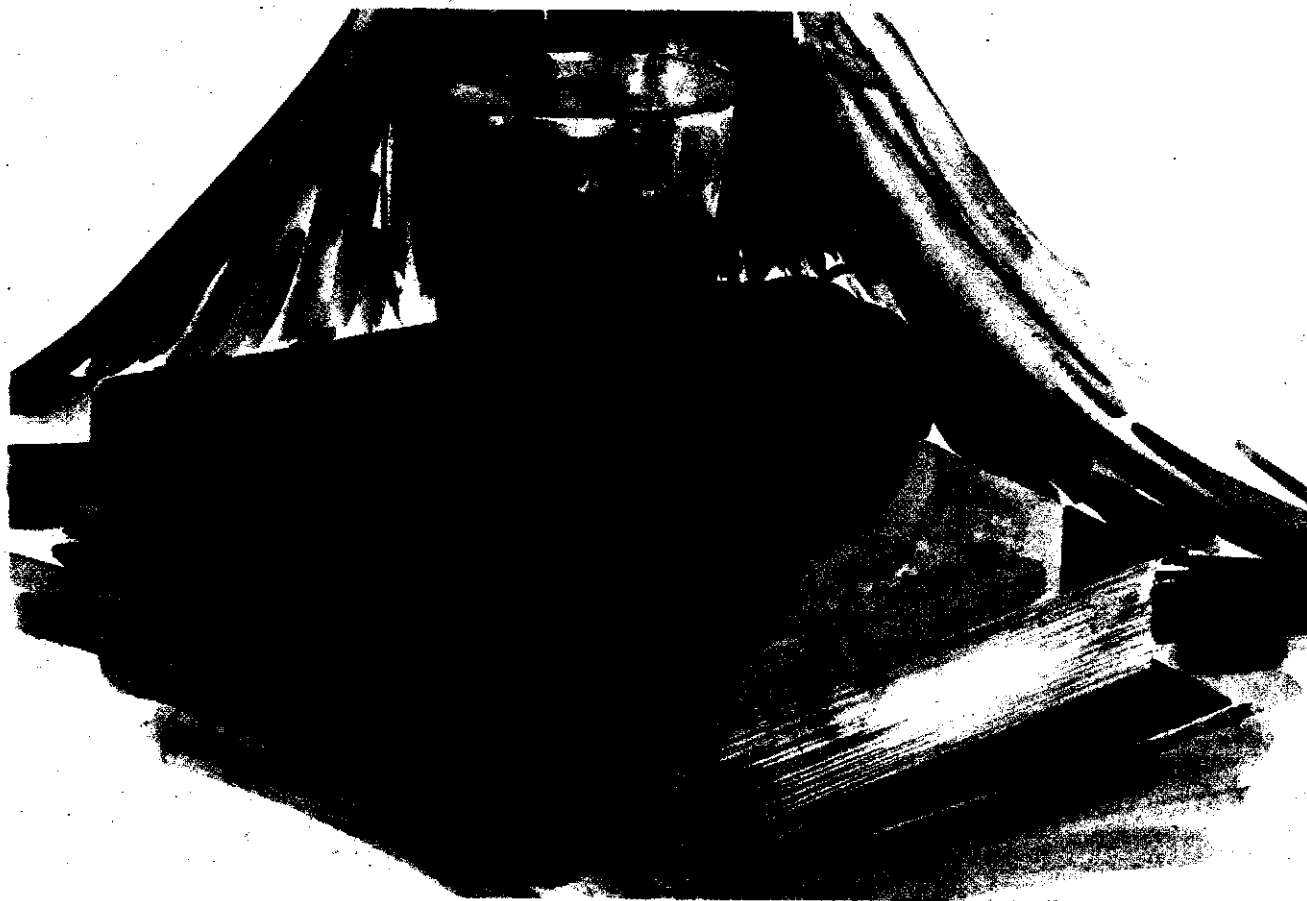

*Fig. 1.7*

### 1.3 MEASURING THE OBJECTS

You can measure the object from distance by holding a pencil vertically with your small finger at the bottom along with other three fingers and the thumb on the top to shuttle it up and down to measure the comparative proportion of the object. (see Fig. No. 1.8). Close one of your eyes and now you hold the pencil at arm's length. Measure from the point to your thumb to compare the sizes of other objects. Hold the pencil at arm's length to ensure a fixed distance between your eye and the pencil.

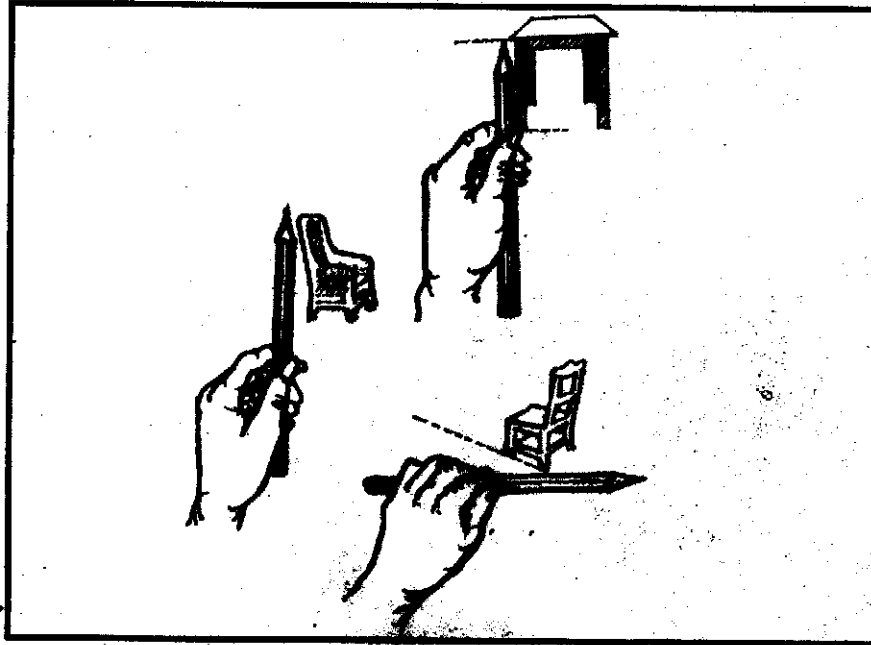

Fig.1.8

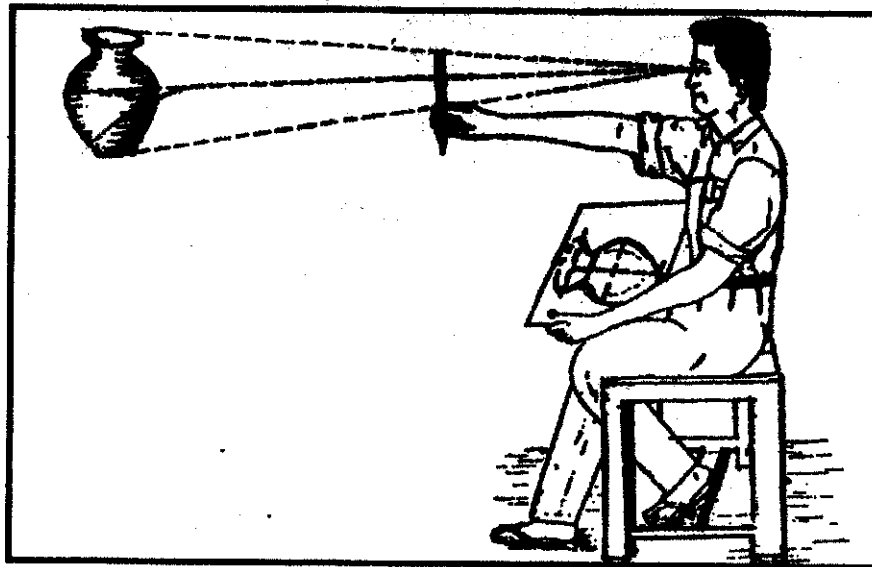
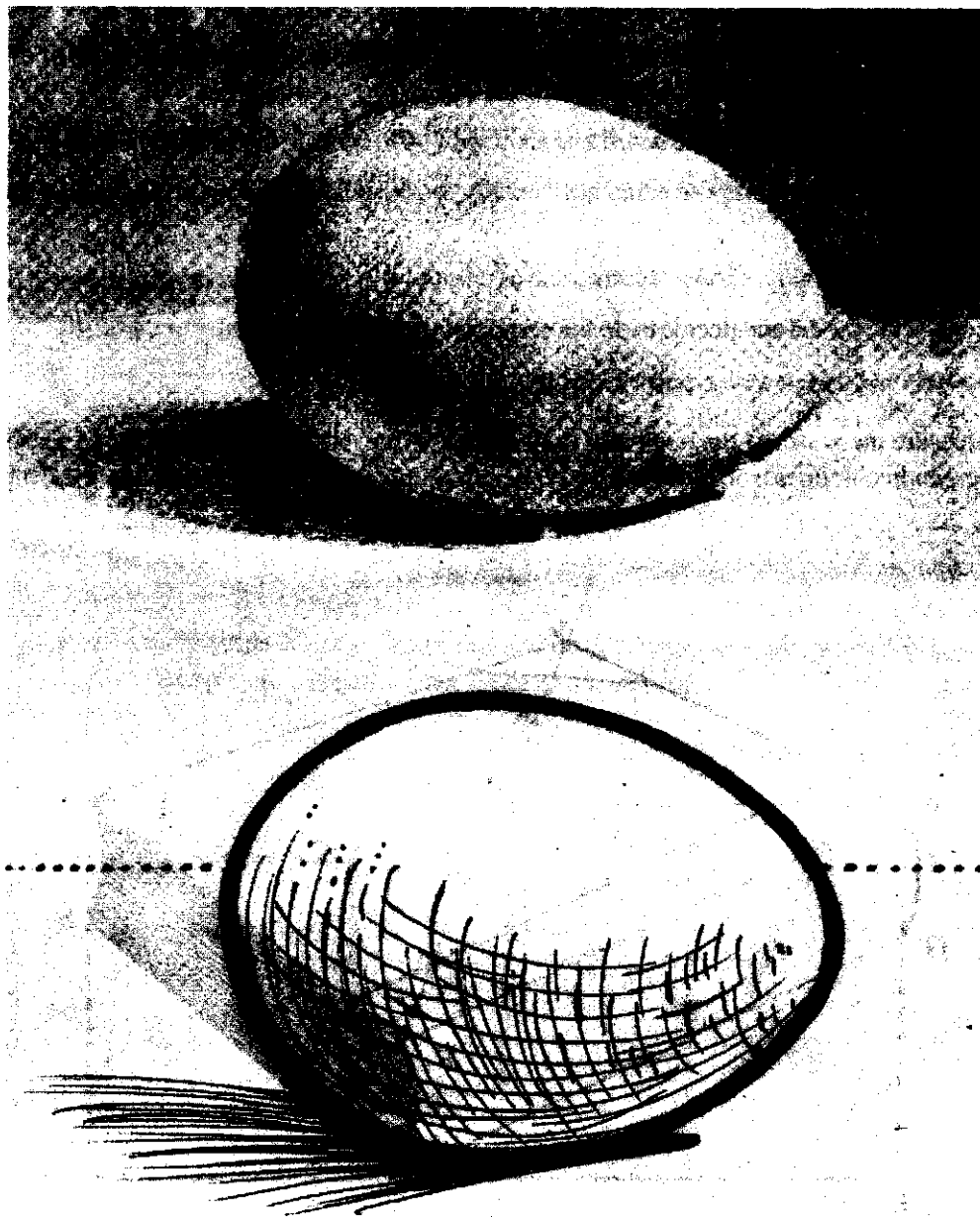

Fig.1.9

#### 1.4 USE OF LIGHT AND SHADE

Since only the outline can not bring the solidity of the object, application of light and shade is required. Notice the source of light as it falls on the object. Other side of the object will be under shadow. Beside this basic flow of shadow and light, there are three other distinction that you should be aware of - highlight, reflected light and cast shadows. Highlight appear as a line or area of very bright light on the surface of the object, particularly on metal objects. (See Fig. No. 1.10)



*Fig. 1.10*

## 1.5 PREPARATION FOR OBJECT DRAWING

**1.5.i Material** - You will need the materials such as pencils, colours, board pins, drawing board, brushes and paper. The choice of drawing material can be as important for the learner as it is for the professional artist. It is worth having a paper suited to the medium like pencil, charcoal etc. Standard drawing pencils are listed according to degree of softness, for example HB, 2B, 4B, 6B, and so on. A drawing board and board pins are needed. Avoid the use of geometrical instruments (Scale, compass etc.).

### 1.5.ii Placing of the model

Place any object or model little below the eye-level. Begin with pencil. Placing of the objects in a well composed manner is helpful.

Set the drawing sheet on the board and fix it with board pins in the four corners.

Make a decision to compose either horizontally or vertically according to the shape of the objects.

To begin your study, choose a form such as a book.

Look at the model and decide to do the composition either horizontally or vertically.

## 1.6 HOW TO DRAW A RECTANGULAR BOOK

Measure the width of the book and draw the base line 'B' to 'D'(Fig No. 1.11). Draw perpendicular lines from points B and D which should be half of B, and D, Mark the top

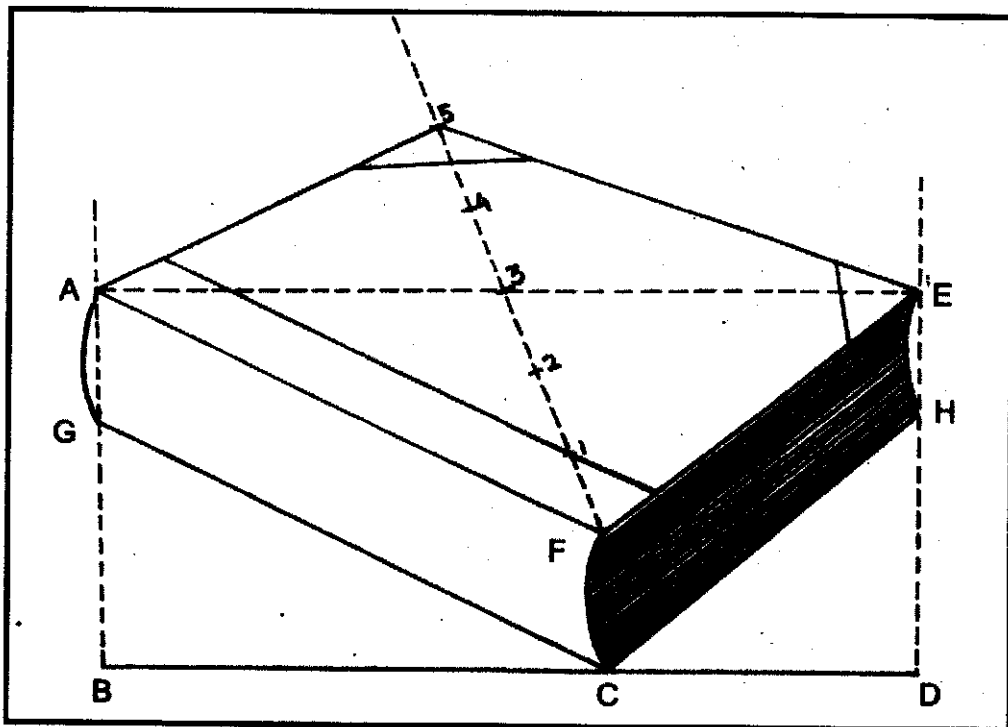

Fig. 1.11

points as A and E. Measure the length of the book and mark with 'C'. Put point F above point C according to the thickness of the book. Put point G under A, and H under E which should be little smaller than CF. Now join A and 'E' with F, and G and H with C. Join 'A' and 'E' and mark No. 3 in the middle of this line. Join this point with 'F' and divide into three equal parts. Extend the same division beyond point 3 to get point 4,5, and 6. Now join point No. 5 with A and E. Now your drawing is ready.

### 1.7 SUMMARY

Object drawing or still life as an art form came into its own in the 16thC and 17thC.A.D. Prior to that time the subject matter was studied primarily as preparation for use in figurative composition.

The subject matters found in object drawing are natural and men made objects of almost any shape and function. An art-student has to learn different aspects and technique of drawing like, perspective, sense of proportion, use of proper light and shade and most of all the sense of composition. One must begin by describing the three dimensional form, then developing texture and values. Lot of practice can only develop confidence.

---

### 1.8 INTEXT QUESTIONS

---

- (a) Find out the errors in perspective in drawing - No (1) and (2), and correct them.
- (b) Place a box on the table, draw it from the front from varying heights.
- (c) Put an apple on the box and draw it.
- (d) See the drawing of the apple on the book. Now put five onions on a table in the same way and draw them.
- (e) Place a ball by the side of a square box and put a lamp in one side. Study the light and shade in pencil. Study the same models in water colour.

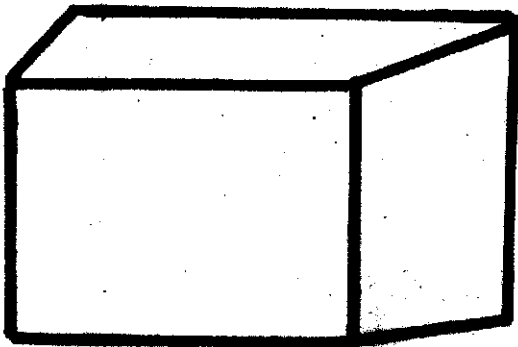

No. 1

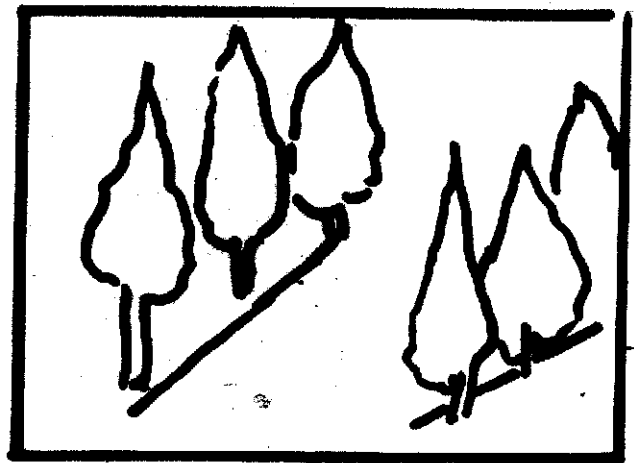

No. 2





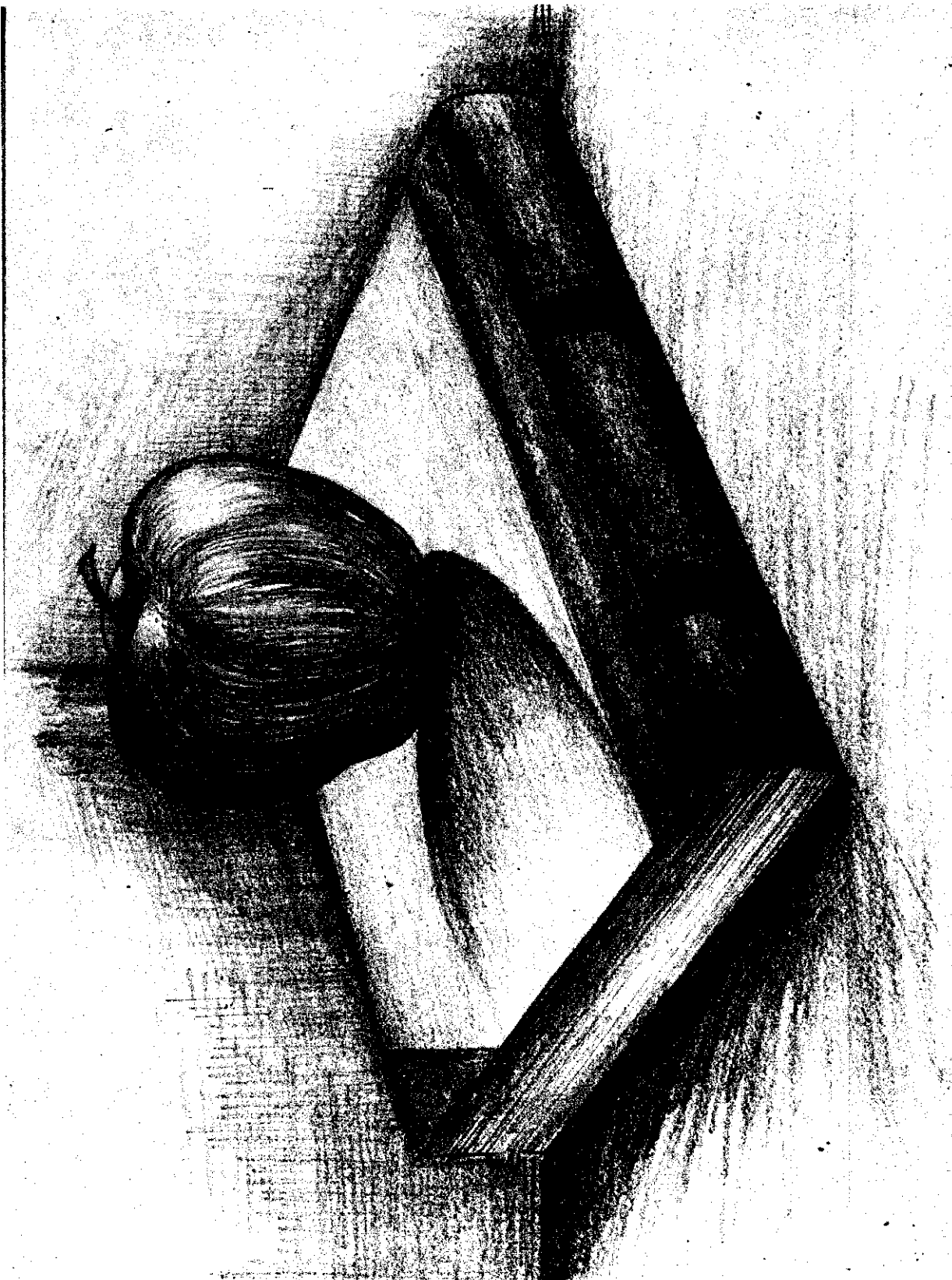

+

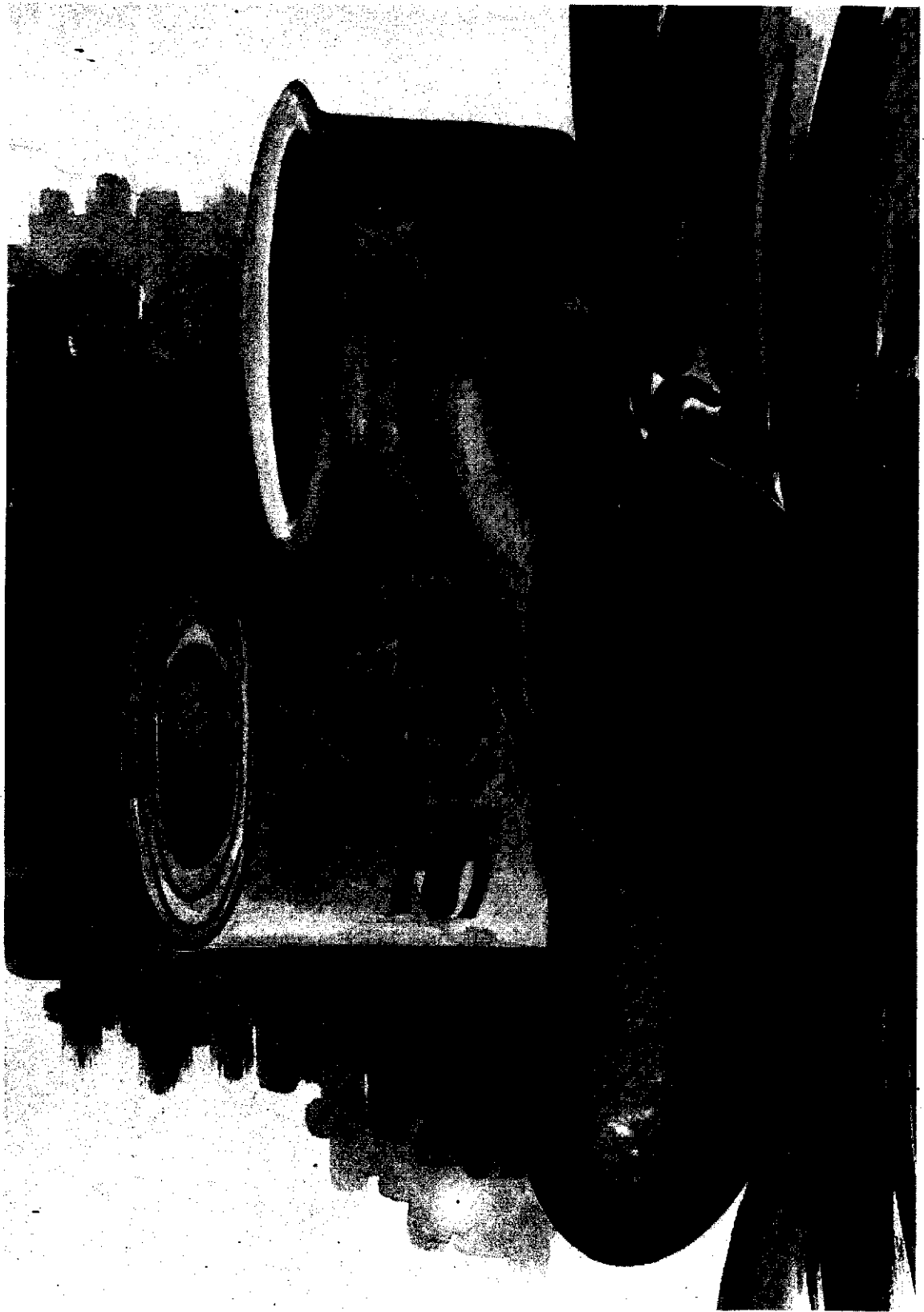





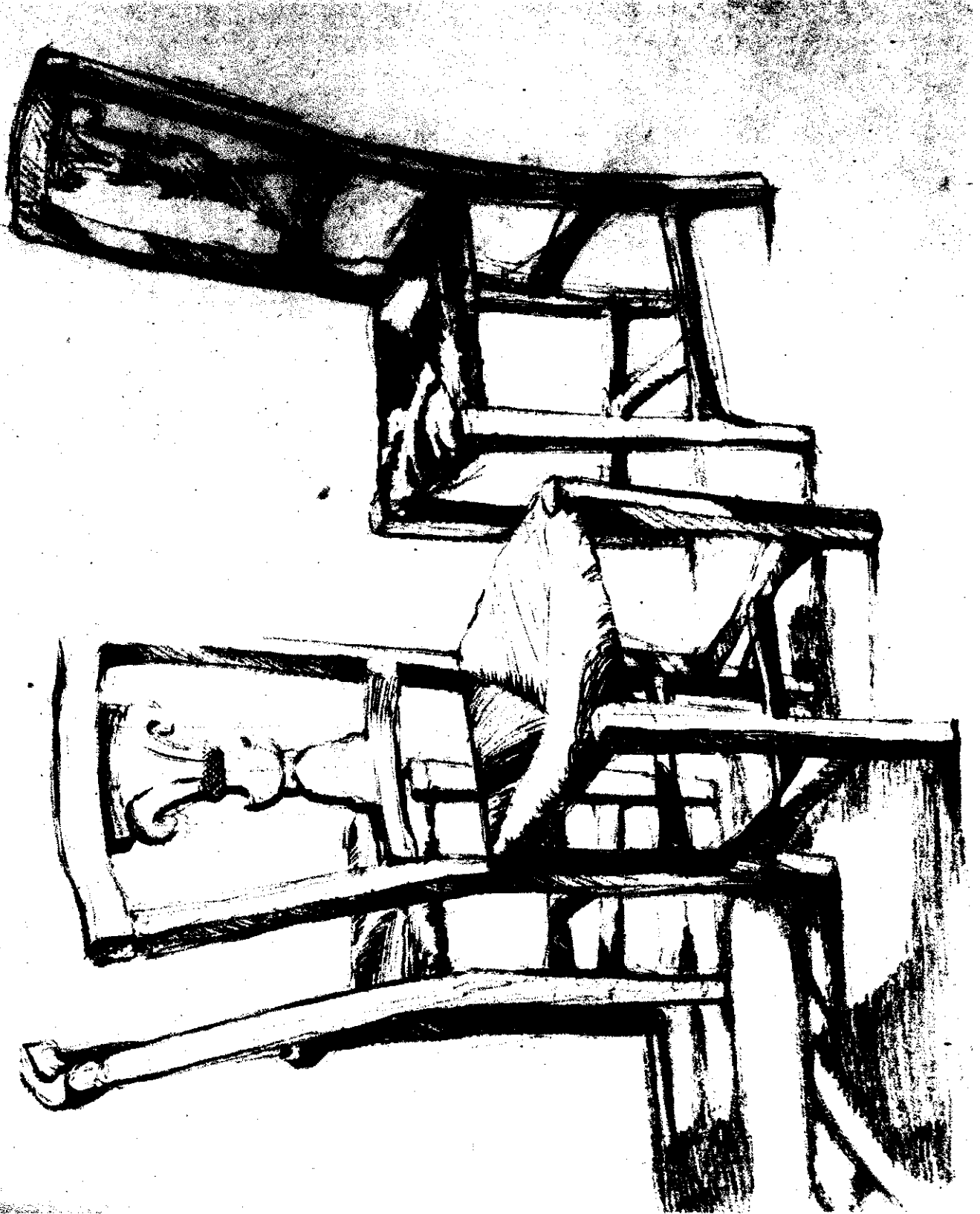



Artist : Chardin



Artist : Chardir





# Nature Study

## 2 INTRODUCTION

Man is a part of Nature. Much of our enjoyment comes from nature which is constantly changing. Man wants to capture the fleeting beauty of nature. Painting nature is one of such attempts.

You look at nature, you will find colour, line, texture and shape in every natural objects like trees, flowers, vegetables and living creatures. When viewing the multitude of natural things it becomes clear that these are in right proportion, balance and rhythm. Look at your own body, and realize all these qualities in the placement, size, balance etc of your eyes, arms, legs and everything.

It becomes very clear that all facts of nature cannot be put on paper, still, with the right combination of lines, tones, space, perspective and composition, we can recollect and communicate our experience and make the viewer a participant in our multisensed response to nature.

### 2.1 OBJECTIVES

After studying and practicing this lesson, the learner should be able to:

- differentiate the right proportion, balance and rhythm, when viewing the multitude of natural things;
- draw the shape of natural objects like trees, flowers, etc.;
- identify the colours of natural objects;
- draw and paint the different vegetables and living creatures.

## 2.2 PERSPECTIVE

Perspective is the means by which forms can be positioned in the implied three-dimensional space of the picture. Knowledge of perspective and proportion is essential in any naturalistic drawing and painting. The object becomes smaller in size and hazy as it recedes from the foreground to the background of the picture. (See Fig. 2.1)

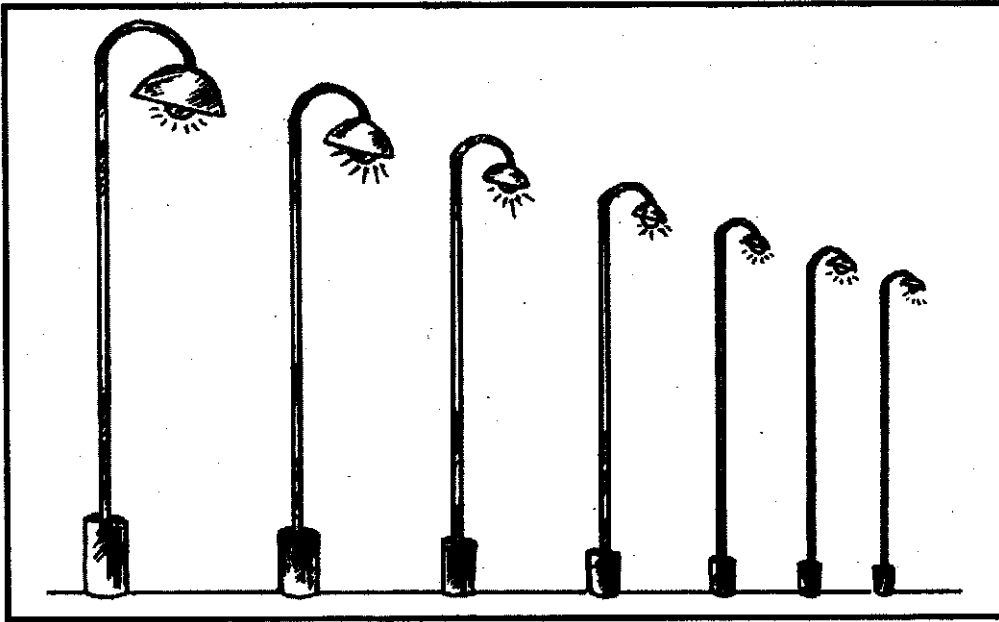

*Fig. 2.1*

## 2.3 BALANCE

A good composition depends on the well-balanced arrangement of form in the space with right proportion. Look at those compositions and it would not be difficult to select the picture as a well-balanced and proportionate composition. (Fig. 2.2)



*Fig. 2.2*

Sometimes the treatment of the background helps to define a natural object clearly. The flower has more volume and depth due to the dark treatment of the background. (Fig. 2.3)

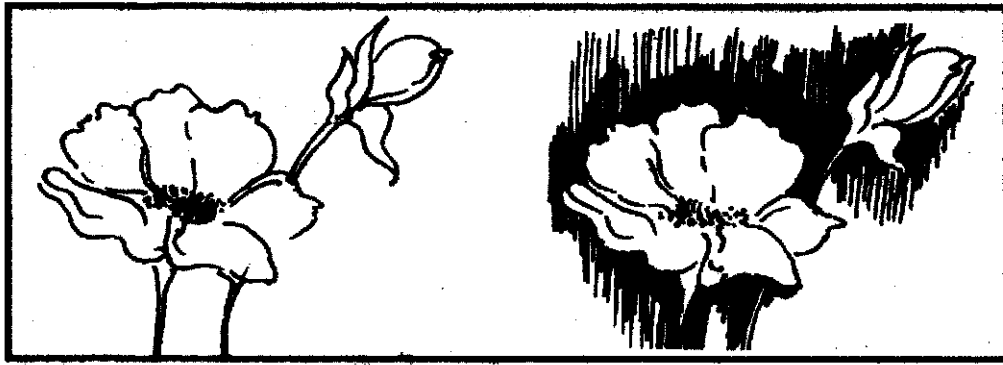

Fig. 2.3

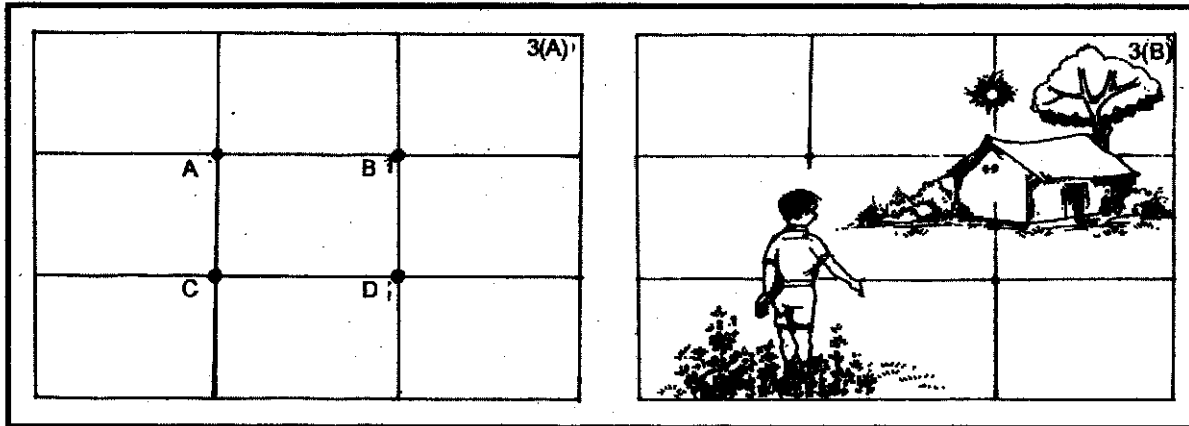

Fig. 2.4

Rhythm and movement give life to a picture. There are many ways to achieve these qualities. Wavy lines etc. can generate life in the picture.

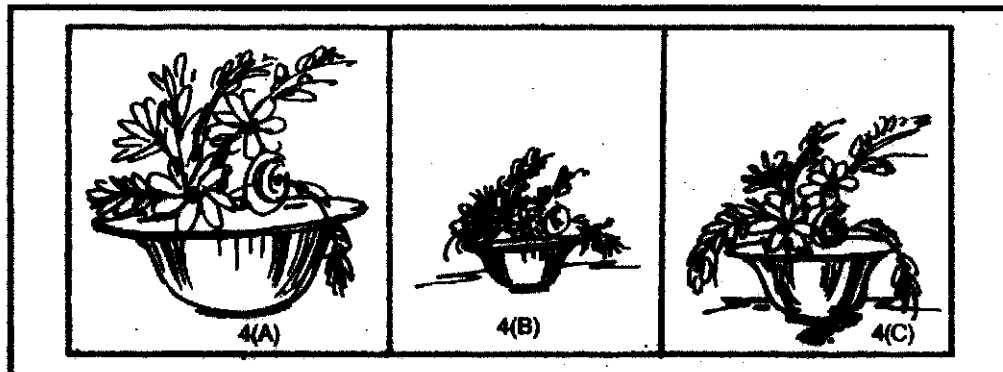

Fig. 2.5

See Fig 4(A) you will find that flower vase is larger than the space given and Fig 4(B) is smaller than the space given but Fig 4(C) is proportionate and fitted in the given space, it is a balanced picture.

## 2.4 PREPARATION

The variety of drawing materials is seemingly endless. For a beginner, it is better to use paper, brush, poster colours and pencils. You also need a drawing board and board clips. It is better to try different kind of lines drawing with pencil before you start the nature study. You can use the brush in the next stage. This will help you to have confidence. It is advisable to practice nature study with pencils, before you do it with colours. You can easily correct your drawing; in case you do any mistakes, which would not be possible in water colour.

## 2.5 LINE

Besides the varied contours and cross contour lines, many other lines and line patterns, have been developed to create shading effects. Always begin with a soft line with light pressure of the fingers, which makes it easy to erase. Shading gives "tone", that means to an area of colour a value of a particular lightness and darkness. Tone also helps to define the perspective. Try to get different values of tone with pencil on a paper. Use your pencil (2B) with very light pressure on the paper to get soft tone. For darker tone, use 4B pencil and put more pressure and you get darker tone. You can use 6B or 9B pencil to get very dark tone.



*Fig. 2.6*

### Try Yourself

Fill the empty spaces in the drawing with different tones.



*Fig. 2.7*

## 2.6 COLOUR

Colour may well be the most subjective element of all. All vegetation is green, but you will use different hues of green for the maximum effects.

There are many kinds of water colour techniques but most common among these are opaque (Poster colour) and transparent use or water colour. Opaque techniques is easier to handle, because you can apply many coats or colour on it and rectify your mistake. On the other hand in transparent technique you can use only one layer of colour. Moreover you can not use white colour. You have to preplan the white area and use the white of the paper to be left unstained.

## 2.7 SUMMARY

In all objects of the nature like trees, flowers, vegetables and living creatures, you will find colour, line, texture and shape as also that these are in right proportion, balance and rhythm. So far drawing any object, knowledge of perspective and proportion, well balanced arrangement of form, treatment of background, line and colour etc., are essential.

### Points to remember:

Following points are to be noted during practice session:--

- Repeat the exercise if you are not satisfied.
- Check the balances of composition of your picture.
- Use the right brush.
- Hold the pencil properly
- Look at your painting from a distance and try to assess it.

### Try Yourself

Use different tones on the flower and egg. (without shading) after watching the shaded drawing.

---

## 2.8 INTEXT QUESTION

- (1) Draw any fruit with outline. Use shades on this fruit each with different types of linear shading.
- (2) Place a flower vase with flowers of different colours. Use opaque colour to paint it.
- (3) Use the same model and paint it in transparent technique of water colour.
- (4) Choose any outdoor scene with trees and plants. Try to get the rhythm balance and proportion in your drawing.

---

## 2.9 GLOSSARY

Texture	- Characteristic of visual quality of the surface
Foreground	- Nearer portion of the space
Subjective element	- Belonging to mind and thought
Hue	- a gradation of a colour
Opaque	- Not transparent
Balance	- a state of harmony, as among the elements of a composition.

---







**Boat Building**

**Artist : Constable**



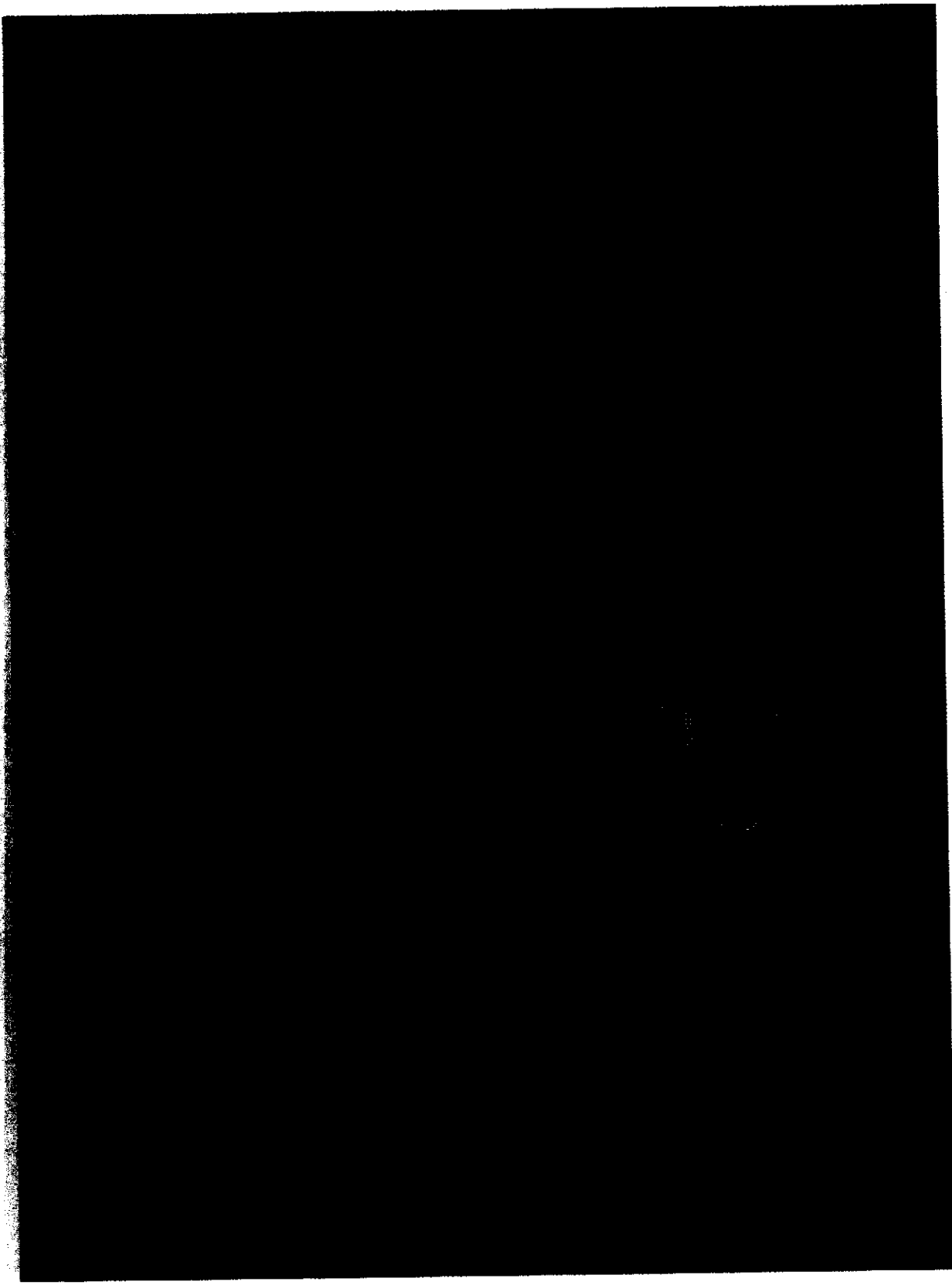

Artist : Monet

The Bridge at Argenteuil



*Arist : Turner*

Venice, from the Canale della Giudecca 1840



# Fundamentals of Painting

## 3 INTRODUCTION

Painting can be defined as portraying an object through the medium of colours or in black and white. A painter works with pigments usually applied to a flat surface by means of a spatula, palette, knife or brush. Today computers can also be used to paint pictures on the screen and later printed, either in colour or in black and white, and as required.

### 3.1 OBJECTIVES

After studying and practicing this lesson learner should be able to:

- identify the materials used to make a painting;
- differentiate between water colour, acrylic and oil colour;
- state the names of different brushes;
- arrange 2 or 3 forms properly in a given space to create a theme;
- handle the materials effectively to create the composition;
- draw animate, inanimate objects and forms.

### 3.2 MATERIALS OR TOOLS ARE REQUIRED

To start with one needs a clean sheet of paper and basic drawing tools such as a pencil and an eraser (Fig No. 3.1). Colour can be added using various mediums such as watercolours acrylic poster colours and brushes of various sizes. (Fig.3.2A and 3.2B) Then again, one can use crayons or other wax-based colours. The above-mentioned mediums are best suited for someone who has just started painting. These mediums give very good results when used on cartridge paper. But one should start with ordinary drawing paper before moving on to more sophisticated materials such as pencils of different grades from B to 4B, eraser and sharpner etc.

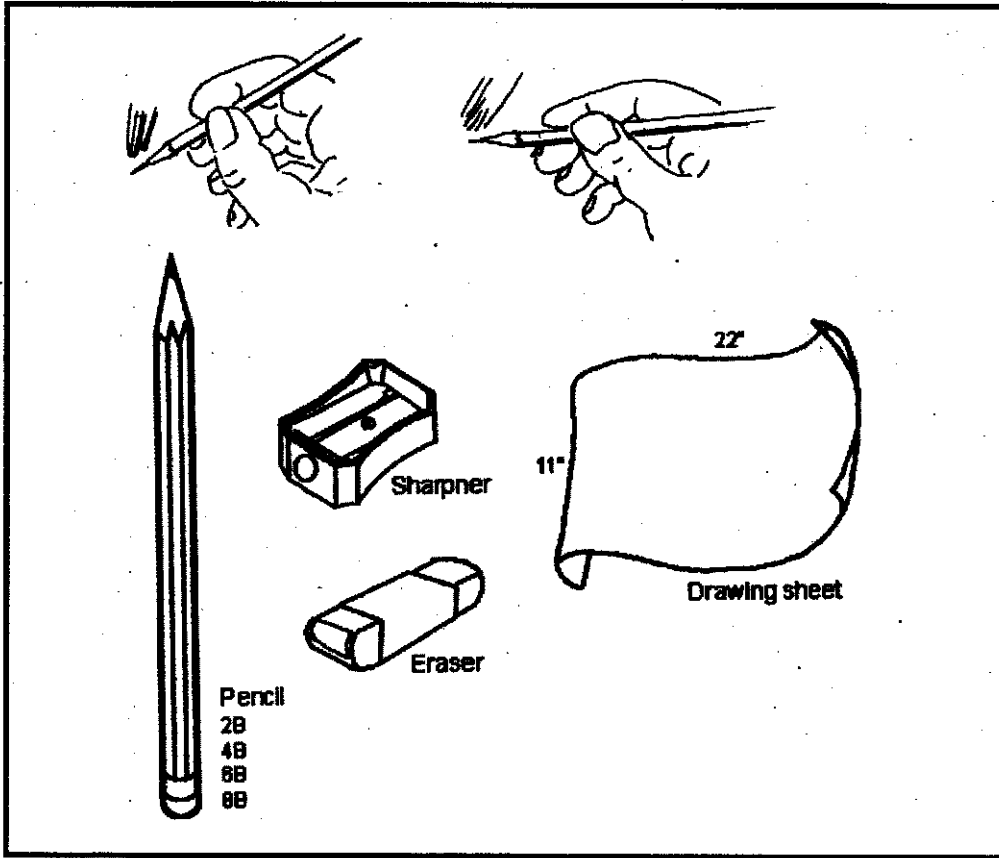

Fig. 3.1

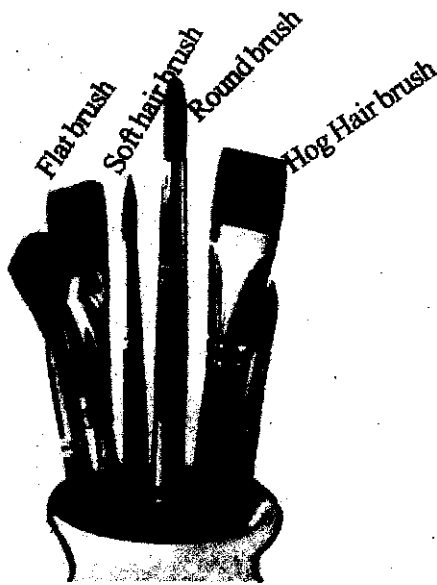

Fig. 3.2A



Fig. 3.2B

**Types of brushes used for painting**

Once a certain amount of proficiency is reached one may shift to oil-based painting on canvas.

**3.3 PROJECT-I**

Choose any simple potted plant or bush that interests you. Observe this object very carefully- the shape of its leaves, the texture of its stem, the variations of colours and also take careful note of the light falling on it. Look at the angle of the light, the areas in shade and the areas that are highlighted, where the shadows are falling. These observations will help you to draw the plant more accurately. Always take time to carefully observe the object you want to paint and don't be in a hurry to put the pencil on the paper. Just this little extra effort may mean all the difference between a good and an average painting (Fig 3.3).

Now take an ordinary drawing sheet and sketch the plant with a soft pencil like 2B. When you have finished, take another paper and sketch the plant again, this time trying to avoid the mistakes that you might have made in your previous drawing. Keep sketching till you don't draw the plant correctly with all the details. Once you manage to do this, take a better quality paper and redraw the same. You will find that by now you are able to paint the plant quite accurately and with considerable amount of ease. Always take care that you keep the drawing in proportion to the size of paper used.

In the beginning it is wise to draw the outline and do some detailing of the plant with a pencil before you start colouring. To get a particular shade of colour not ready-made on the palette, one may need to apply coats of colours, one on top of another. This could go on to many layers depending on the colour that is required to be portrayed.



*Fig. 3.3*

### 3.4 PROJECT II

Pick any other simple still-life subject that may be painted using poster colours. Keep in mind that such a subject should mostly be of high contrast in nature. This means that there should not be many areas of medium tones - the object must have highlights and dark tones; no mid tones. In such a case, drawing with pencil is not required.

However, before starting on a poster colour artwork, it is important that you understand the difference between opaque and transparent colour. A high contrast painting uses more of opaque colours such as poster colours, while soft merged pastel effects are achieved by using transparent colours like watercolours. In opaque paintings, the colour is generally thick and white is used frequently for tonal variations, whereas in transparent paintings a small amount of colour is mixed with a larger amount of water and applied in such a manner that it flows and the base colour is seen through. (Fig. 3.4)



Place the objects on the top of a table or on a board. First draw the objects in pencil outline. Cover the objects with first tone (Water Colour)



first tone  
*Step 1*

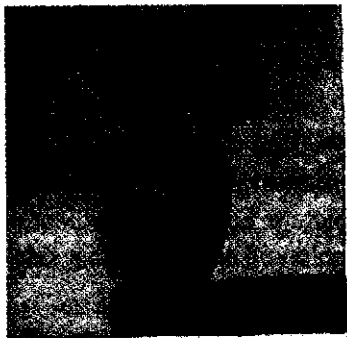

Let the first tone dry. Apply the second tone and let it dry again.



second tone

*Step 2*

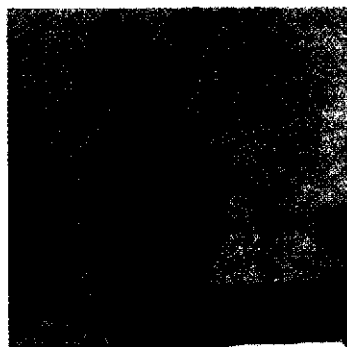

Let the second tone dry. Apply the third tone and let it dry again.



third tone

*Step 3*

Fig. 3.4

\*Colour used - Prussian Blue & SAP Green

### 3.4 ATTRIBUTES OF A GOOD PAINTING

There are many attributes to a good painting. One will be able to create an attractive painting if one understands both the aesthetic and the technical aspects of a painting. A few important qualities one must keep in mind while painting are rhythm, balance, harmony, composition, colour and subject matter, light and shade, texture, perspective, centre of interest, handling and originality.

Let us discuss the following qualities in brief:

**Rhythm :** Rhythm is an element used to create the illusion of movement. This effect is mostly achieved by repetition of lines, shapes and/or colours. This rhythm is present in all forms of art like poetry, dance, music, etc. An example could be a series of birds or cattle, painted one after the other with slight variations in shapes and sizes. This would bring about a feeling of the birds flying and the cattle on the move. (Fig 3.5A)



*Fig. 3.5A*

**Balance:** Balance is the principle of design that deals with visual weight in a work of art. This refers to the quality of introducing a figure, colour or mass in a painting to counteract the effect of another element dominating the scene in the picture. For example a giant tree on one side of the frame can be balanced with a bright redcoloured hut on the other side of the frame. (Fig 3.5B)



*Fig. 3.5B*

**Harmony:** Refers to ways similarities in a work are accentuated to create an uncomplicated, uniform appearance. Harmony is achieved by repetition of characteristics that are the same or similar. Harmony is a pleasing relationship between parts of an artwork. It is the quality of rhythmic composition in a picture - the opposite element is as important as the elements in the front and the back. Both play useful roles when used properly. (Fig 3.5C)



Fig. 3.5C

**Composition:** Composition is the arrangements of visual elements in a work of art. The elements combine together in a certain form to create a unified whole. And it is the conscious decision of the artist to place various elements that might determine the effectiveness of the painting. All three preceding qualities - harmony, rhythm and balance have to be kept in mind while making a composition. A good composition means to put all the elements in a befitting manner. Before arriving at a satisfying composition you have to make several sketches.

**Colour:** This is an element of art derived from reflected light. The sensation of colours aroused in the human mind as vision responds to various wavelengths of light. The three properties of colour are hue, value and intensity. To create a painting to one's satisfaction one has to be very judicious about choosing the colours that one uses. For instance, if one is trying to portray a happy summer day one ought to be careful with black and grey tones, since using too much of these colours might bring about a feeling of sadness rather than a cheerful mood. Similarly if one wants to portray a scene with a lot of unrest an agony one should not use a lot of white colour, instead the colour red should be the choice of the artist.

**Subject:** It is the topic or idea represented in an artwork. If one wants to do justice to a subject then one should be ready to observe the subject for a long period of time. This observation would facilitate the understanding of the subject and hence the artist would be in a better position to paint it accurately.



Paintings that depict the subject in a realistic manner and in their true form are known as naturalistic or representational works. Others that slightly distort the subject matter are called semi-representational or semi-abstract works. Still others that do not use any recognizable subject from the world, but only shapes generated in the imagination of the artist are known as non-representational or non-objective paintings.

**Focal Point (Centre of Interest):** It is that area of an artwork which immediately attracts the viewer's attention. This is the area of action in painting, the area the artist wants us to view first. Contrast, location, isolation, convergence and the unusual are used to create focal points. (Fig 3.5D)

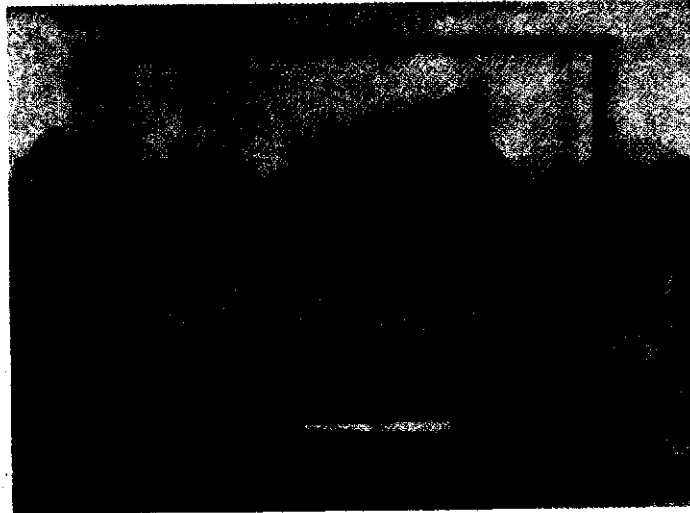

*Fig. 3.5D*

**Texture:** Texture is the element of art that refers to how things feel, or look as if they might feel, if touched. It refers to surface quality - rough or smooth. This character can be attained by the quantity of colour used or how it is applied on the painting area. Brush or pencil strokes can be used to bring forth the feeling of texture. Fig. 3.5E



*Fig. 3.5E*

**Perspective:** Is the method used to create the illusion of space on a two-dimensional surface. It is usually created by size variations. The theory of this optical illusion is that the further away an object is from a person, the smaller it looks. If we look at railway track, the lines that are actually parallel seem to get closer and closer as they move further and then finally merge. This point where they merge is called the horizon.

Most students while painting make the mistake of putting the cart before the horse. They feel that if they can master the handling of their materials, they can paint well. Though learning all skills are essential. One must first take time to study observe the subject in great detail. The student should know what is the context of the subject: Is it a grim or cheerful subject, is it dynamic or one with an atmosphere of absolute stillness, then again is it indoors or outdoors, and so on. Once you are sure about the context and the feel of the subject, then you should give a good amount of thought to which medium would be the most appropriate to execute the painting in.

When colouring, one must be careful about how much colour one uses. Especially in case of transparent paints, such as watercolours, one has to be judicious with the amount of colour one picks up on the brush. Too little, and the painting has not tonal variations. Too much, and the effect becomes jarring. You may need to darken or lighten the paint so that it recreates the illusion of various masses and volumes on a flat surface. The judicious use of colour can also effectively create the feeling of the third dimension-depth.

In your painting depth, light, air and space should be given due importance and you must always keep these elements in mind. At the onset, it is wise to keep the elements in the paintings as simple as possible. As you move on, you will be able to work upon these simple elements to bring forth all the complexities of the subject at hand. And this will happen only with practice and by constantly painting the same subject again and again. Every time you repaint the subject, you will be able to achieve a higher level of precision. With time you will acquire the ability to look at a subject and decide what are the main elements - what makes the subject attractive. Most often, the minute details are not important in a painting, but the overall effect. For example, you need not show how many bricks there are in wall or leaves on a branch. You must instead try to capture the pattern created by the play of light on the subject - the light, dark and medium tone of the areas.

You also have to bear in mind that a truly successful painting has about it an aura of complete sincerity and honesty. It should bear the imprint of the artist. It should have something that would let the viewer recognise and relate to the painting instantaneously.

### 3.5 INTRODUCTION OF COLOUR

The enjoyment and appreciation of colour is universal. It plays a very important role in our lives. It can excite and soothe, or even lift us to heights of emotion. For example, red is used to signify danger while blue represents calmness and tranquility.

Colour is also a very powerful component of any painting. It communicates the mood and message of the painting. Colour is like the dress that makes one distinct in a particular setting from the rest. It differentiates.

For any student of art, it is very essential to have a full knowledge and understanding of the Colour Wheel.

**Colour Wheel:** The Colour Wheel describes the relationships between colors. It is an artists tool of the colour spectrum bent into a circle displaying primary, secondary and intermediate/tertiary colours and useful in organizing colour schemes. (Fig 3.6)

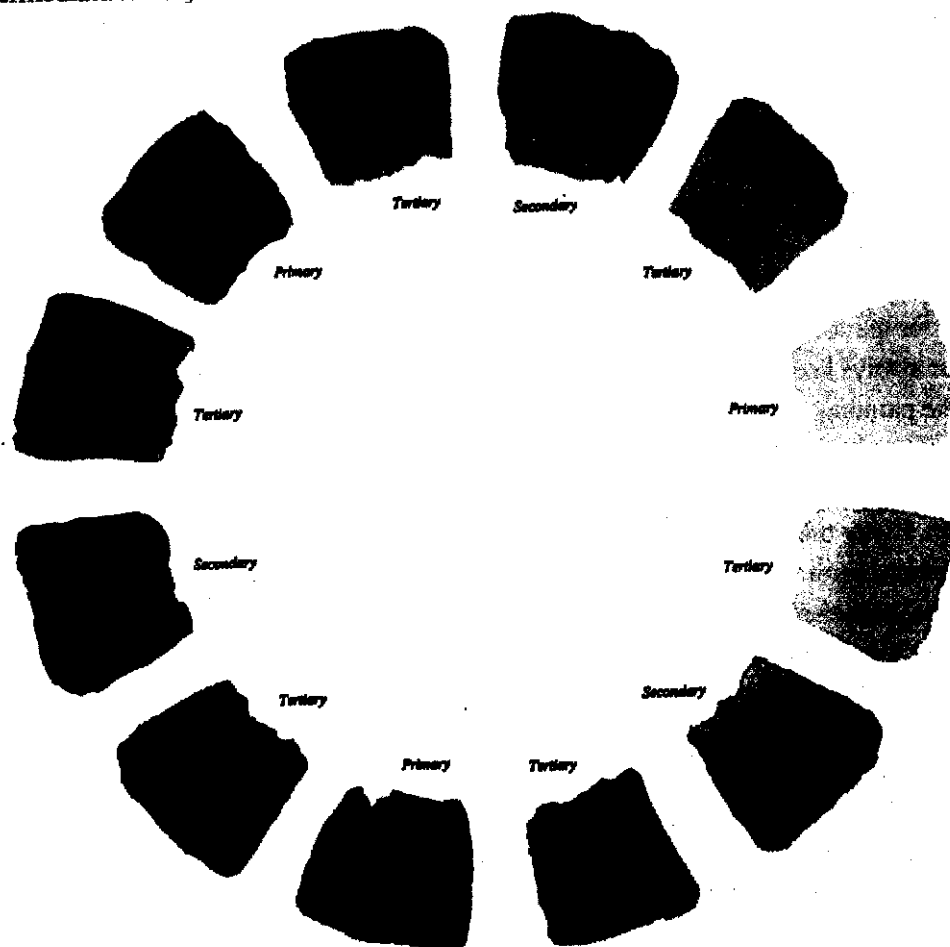

Fig. 3.6

**Primary Colours** are basic and cannot be mixed from other elements. Three primary colours are 1. Red 2. Blue 3. Yellow.

These three primary colours when mixed together produce the secondary colours as gives:

Red + Yellow = Orange  
Blue + Yellow = Green  
Red + Blue = Violet

If you mix a Primary colour with its adjacent Secondary colour, this gives a Tertiary colour and classed as third in order.

The cool colours reside on the blue-green side of the wheel. These colours appear to move away making areas seem more spacious. Less so however with the darker shades.

The warm colours on the red, orange and yellow side advance towards us making an area seem more intimate but smaller. They are the attention getters, great for attracting the eye.

The colours close together on the wheel will always compliment, making subtle schemes either soft in pastels or more austere in the dark shades.

The colours opposite each other on the wheel are the contrasting colours and they are always dramatic and bold.



Red and green are equal in intensity and light, so they should occupy equally proportioned areas of a painting.



Two-thirds blue and one-third orange together give the correct balance, as orange is more vibrant and intense.



Two-thirds blue and one-third orange together give the correct balance, as orange is more vibrant and intense.

*Fig. 3.7*

### 3.6 WATER COLOURS

Painting in watercolours requires a high degree of mastery over this medium. It calls for a combination of skill, knowledge, patience, and even courage.

Watercolours can be easily obtained from the Art Material shops. These pigments are available in tubes, cakes or jars. The cakes and tubes are the traditionally used forms that provide the typical translucent watercolour effect; the jars, better known as poster colours, are thicker and need more addition of water. They are used mostly to produce the opaque effect. Other colours are pastel, or acrylic & fabric colours.

One need not buy all the available shades of watercolours in the market. A few well-selected colours on your palette can provide you with a vast range of colours. The following colours are suggested to begin with:

Two yellows	-	Ochre and Chrome
Two reds	-	Crimson and Vermillion
Two blues	-	Cobalt and Ultramarine
One brown	-	Burnt Umber
One green	-	Viridian and sap-green
Lamp black	-	Lamp black

The correct selection of colours for one's palette is something learned only through experience - by trial and error.

There are two types of quality available in watercolours - 'Students and Artists'. 'Students watercolours are less expensive but also lack in quality. When you buy your paints try if possible to purchase Artists' quality, the extra money spent will be worth it.

The same applies to brushes. You need at least three basic brushes: No. 3, 7 and 12. Buy good quality brushes; these last longer and also give you better results. Sponges also can be used when applying water colour paint to large areas, and are always a good option to keep on your list.

A palette is another important tool for an artist. A lot of plastic palettes are available with Art Material shops. These are cheap, durable and handy. Though people sometimes use cups and saucers in absence of a palette, no serious artist can do without one. A cup doesn't allow you to give different strengths to one pigment, while a saucer doesn't serve to keep different pigments separated.

The other requirement is a container for water. A plastic mug with a wide neck will do. The container should have a large neck as this lets you wash quite a number of brushes at a time. And it is essential that the brush should be washed very thoroughly after each application of colour, any remnant of previous pigment can spoil your painting.

A good wooden board is also required. This too is readily available from an Art Material shop.

It is also very important to take good care of your art material. Always insure that your colours tightly capped as they may dry out otherwise. Also use up colours soon..... keeping them too long can make the pigments loose their strength and tone.

Brushes should not be left in water as this will spoil their bristles. Clean and dry them properly. After each use, insure that their bristles are together and tips pointed when drying. Store them in a clean box when not in use.

Before starting work with watercolours one more precaution should be taken. It is about preparing the paper to receive watercolours. As you know, when water is dropped on paper the paper tends wrinkle unless it is very thick. This is to be avoided. To overcome this difficulty we stretch and secure the paper to the board in the following manner:

- Step 1** - Sponge the paper on both sides so that it is uniformly wet.
- Step 2** - Place this wet paper on the centre of your board as flat as possible. Sponge-off any surplus water.
- Step 3** - Use a strip of gummed tape along the long edge of the paper to stick it down to the board. Keep half the width of the gummed tape on the board and other half on the paper.
- Step 4** - Smoothen the paper again and stick down the other long edge. Next stick the sides of the paper on the board.

Only if the paper is very thick and heavy it can be safely used for water colouring without stretching.

The most important quality of a water colour painting is that it must be soft and flowing- the colours must be well merged without any hard edges. A watercolour painting can be both bold and delicate, strong and gentle. Try and maintain these contrasting qualities in all your work of art. Your painting must not have stiff or hard patches of brittle and half-dry colour. It is also possible to make a perfect painting in the first go. Watercolours is about perseverance and practice. Remember, do not try to tackle too much too soon. Look for a subject you feel you can manage and be content at this stage with 'studies'

rather than paintings. A small sketch-book is very important to any aspiring artist. Use it all the time to capture interesting references and practise your sketching.

### 3.7 MONOCHROME PAINTING

Is a painting whose colour scheme uses only one hue and its tints and shades for a unifying effect. Basically this means working with one pigment only. Think of a black and white photograph where the only colour is black used in varying tone and you will get a clearer picture of what one means by a monochrome painting. Except that in a monochrome one need not limit oneself to just tonal variations of black, any one colour - blue, green, red, purple - will do. (Fig No 3.8)



*Fig. 3.8*

The paint has to be mixed and applied in varying degrees of strengths to create the different tones in such a painting. The term generally used is weak and strong colour. A weak colour is one where so much of water has been introduced to the pigment that the colour effect is highly reduced. A strong colour retains a higher quantity of pigment and the colour created is deeper and brighter.

Start a monochrome painting by choosing the subject and the one colour you wish to render it in. For example, let us imagine that the subject for the painting is the scenery of a village. Now such a subject would comprise of obvious elements such as the sky, mountains, river, huts, trees, etc. First draw simplified outlines of the various elements of the scene in light pencil. No detailing is required initially as this would be done later

when adding colour. Now get the colour ready on your palette. In case it is not a ready-made pigment, insure that you mix enough colour to finish your whole painting. It is near impossible to mix the same colour again. And slight difference in hue could spoil the whole effect.

With the colour mixed on your palette, ready to be strengthened or weakened as required, you can start painting. With a well-loaded thick brush (No. 10 or 12) of paint quickly fill in the colour in the sky area right down to the where you have drawn the outline of the mountains. Next paint the mountain in a slightly darker tone. After this, take a smaller brush to colour the trees, huts and foreground is done in a still stronger tone. Start detailing with gentle tones of the water in the river and the more lightly shaded areas on the rocks. Now fill in the broader area of stronger and deeper tones after carefully considering how wet or dry the surface should be - basically whether you need a harder or a more merged effect. lastly the more delicate details such as leaves on the trees or straw roofs of the huts can be filled in with a pointed brush like No. 2 or 3.

### 3.8 SUMMARY

Painting is portraying object or objects with colours or black & white. Material required for paintings are powder colour, cake, tubes, poster colours, acrylic colour in tubs and small jars, pastel colour (dry or oily) stick, oil tubes, turpentine and pure linseed oil. canvas coated with primer and oil sketch paper. For water colour soft brushes made of squirrel or sable hair or synthetic brushes No. 3, 6, 12 and a flat brush of ½" For oil painting hog hair brush no 3, 9, 12 are used. A view finder is very important for comparing picture. First handle the object (still life) drawing with one colour i.e., monochrome painting. After handling with monochrome colour work with limited colour and try to give the proper shape, tonal variation, highlight, shade and shadow.

---

#### INTEXT QUESTIONS

---

1. What tools and material are required for painting.
2. Describe the attributes for a good painting?
3. What is 'Colour wheel'? Explain it.
4. Describe the different steps of application of water colour.
5. What is monochrome painting? Describe the techniques of this Painting.

### 3.9 GLOSSARY

**Acrylic colour:-** synthetic resin used in and emulsion as the binding medium, Artist's quality water colour paints. The best quality water colour paints with high pigment loading and strong colour.



**Adjacent colours:-** the colours wheel but also used to describe colours which lie next to each other in a painting complimentary colours - those colours of maximum contrast opposite each other on the colour wheel. For example, the complimentary colour of a primary colour is the mixture of the other two primaries i.e. green is the complementary of red, because it is made up of the yellow, blue and purple is the complementary of yellow because it is made up of Red & Blue.

**Cool Colour:-** A colour such as blue is considered cool. Distant colours appear more blue due to atmospheric effect and cool colours are therefore said to appear to recede.

**View finder:-** A rectangular hold to the scale of the artists paper cut in a small piece of card board to act as a framing device. This is held up at arm's length and the scene to be drawn or painted is viewed through it.

**Focal Point:-** In a painting, the main area of interest visually.

**High Light:-** The lightest tone in drawing or painting. In a transparent water colour techniques on a white paper highlights are represented by the white of the paper. In a opaque painting, highlights are represented with opaque white colour,

**Impasto:-** A thick application of paint

**Perspective:-** The method of representing three dimension on a two-dimensional surface. Linear perspective makes object appear smaller as they get further away by means of a geometrics system of measurement. Aerial perspective makes a sense of depth by using cooler, paler colours in the distance and warmer brighter colours in the fore grand.

**Pigment:-** Solid coloured material for all types of paint.

**Primary colours:-** The three colours, red, blue & yellow which cannot be produced by mixing other colours and which in different combination form the basis of all other colours.

**Stretching the paper:-** The process by which water colour is stretched to prevent it from buckling when paint is applied, the paper is wetted by sponging buckling when paint is applied, the paper is wetted by sponging or dipping briefly in water. It is then attached to a board with gum strip and allowed to dry.

**Tertiary colours:-** Colours which contain all three primaries.

**Tonal variation:-** The degree of darkness or lightness of a colour.

**Warm colour:-** Generally a colour such as orange - red. Warm colour advance towards the viewer whereas cooler colours appear to recede.

# 4



332en04

## Composition (How to make a painting)

### 4 INTRODUCTION

Composition in painting means selection and arrangement of animate or inanimate objects within the given space to express the artist's ideas or imagination properly and effectively. At the very beginning, we may go for non-figurative composition.

#### 4.1 OBJECTIVES

After studying and practicing this lesson the learner should be able to:

- arrange two or three forms properly in a given space to create a theme.
- handle the materials effectively to create the composition.

#### 4.2 GEOMETRICAL FORM OF COMPOSITION

Take one black sheet of paper. Cut it in different shapes and sizes - circle, square, triangle or different shapes. Instead of one black colour, you may go for different colour paper also.

Lay these cut pieces on a light colour sheet or white sheet of paper in different ways to cover the empty space of the paper. It helps to develop the basic compositional idea, which will also help to develop the idea of proper balancing of the covered area. The covered area is known as positive space and uncovered area is negative space. (see fig 4.1)

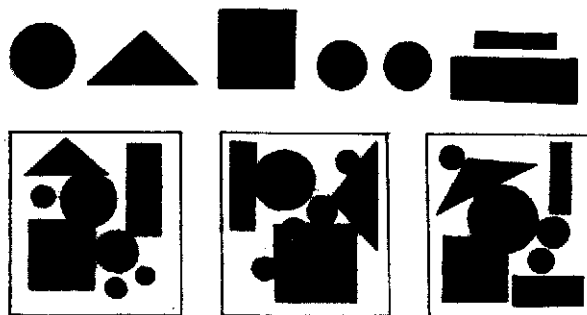

Fig. 4.1

Before starting a painting in water colour, oil colour, pastel colour or any other medium "a composition" is must, based on which the painting will be done. Even before thinking about the composition, one should think about the selection of subject/ theme of the painting. Namely - Mother and Child, Market place, Bus stop, Village scene, Landscape etc. Select any one from the given subjects. For example - we select 'Mother and Child' as theme of our painting.

Now we shall make several sketches of Mother and Child from life as ready reference. (Fig. 4.2)

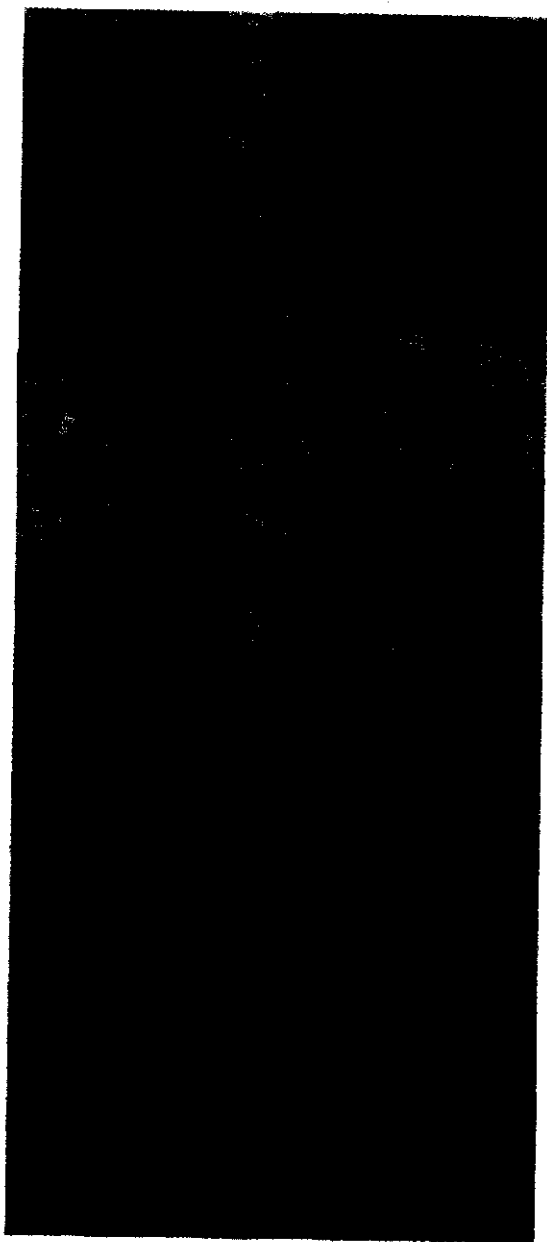

Fig. 4.2

Along with drawing one should sketch surroundings also, as background of the painting. Shapes of the picture/composition area will be rectangular but horizontal or vertical as many as possible sketches of Mother with Child from different angles, various surroundings, if possible with tonal effect adding light and shade. Pencil sketches at the starting will be preferable. Pen and ink sketches with wash-tone can also be given.

## NOW YOU GO FOR SELECTION

Out of good composed sketches you may select one for painting, in water colour, tempera (water colour mix with white colour to make opaque colour) or pastel colour etc. Some sketch examples are given for basic guidance. (Fig 4.3A, 4.3B)



*Fig. 4.3B* -

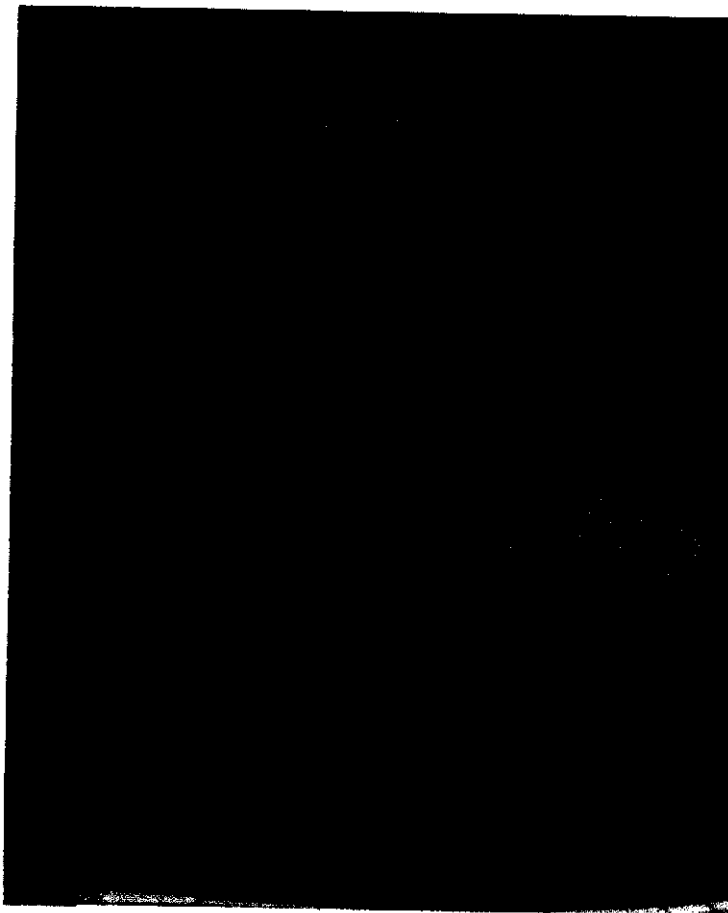

*Fig. 4.3A*

Consciously or unconsciously every day we also do composition work in our room decoration/room arranging work, drawing room table arrangement work. A nice table arrangement can be converted into a 'still life' painting composition. In still life composition one should keep in mind that balance - proper arrangement or display of objects, which will cover the picture surface or empty space of paper/canvas.

### 4.3 COMPOSITION - OBJECTS STUDY/STILL LIFE COMPOSITION

In our still life composition names of some elements are given herewith - simple objects like Jug, Tumbler, Basket, Bottle, Cup, Fruits, Books, Vase, Box, Cloths, Plants etc. are suitable on floor. For still life - some objects to be collected and to be displayed on a table.

Learner can select his/her objects as per availability. But colourful objects are preferable.

Learner is suggested that he/she can arrange the available objects according to his/her idea / imagination. Before going for final he/she should go for rough pencil drawings. Then go for final drawing on an art paper for water colour/pastel colour or canvas for oil colour painting. (Fig 4.4)

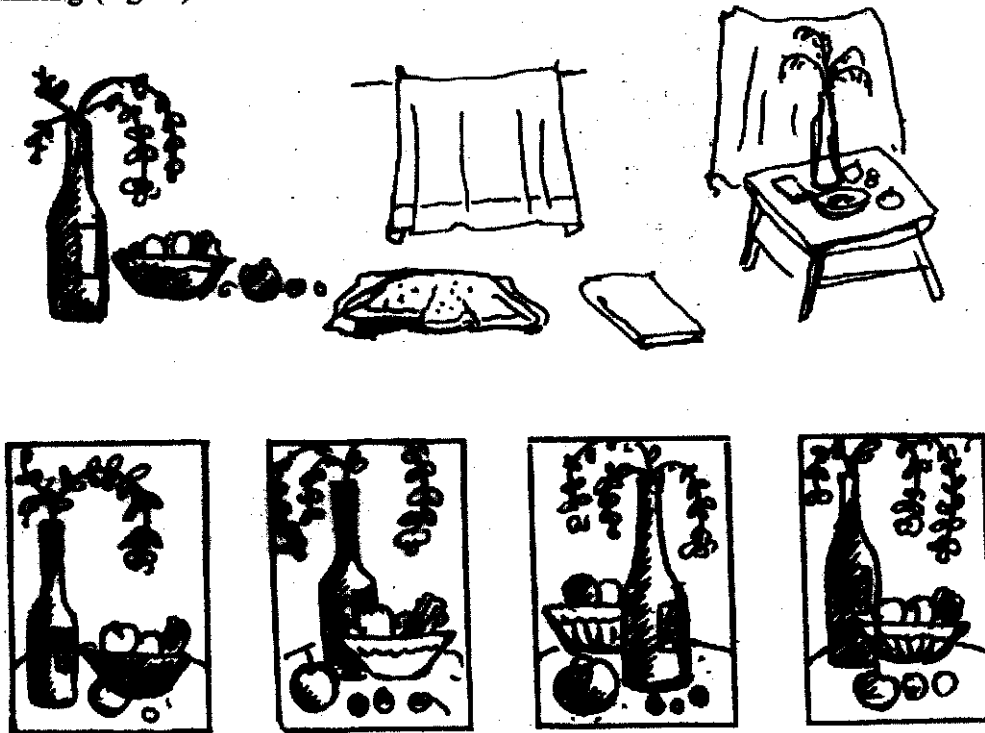

Fig. 4.4

### 4.4 COMPOSITION BASED IN NATURE

Our subject is nature study - landscape of village corner, rail station. Day-to-day life-festivals, library corner, kitchen corner etc.

Suitable shape is horizontal. Subject is village corner. What we see generally in a village - huts, trees, domestic animals like cow, dog, goat, human figures, birds; and at a distance - river, hills, boat on river, wells etc.

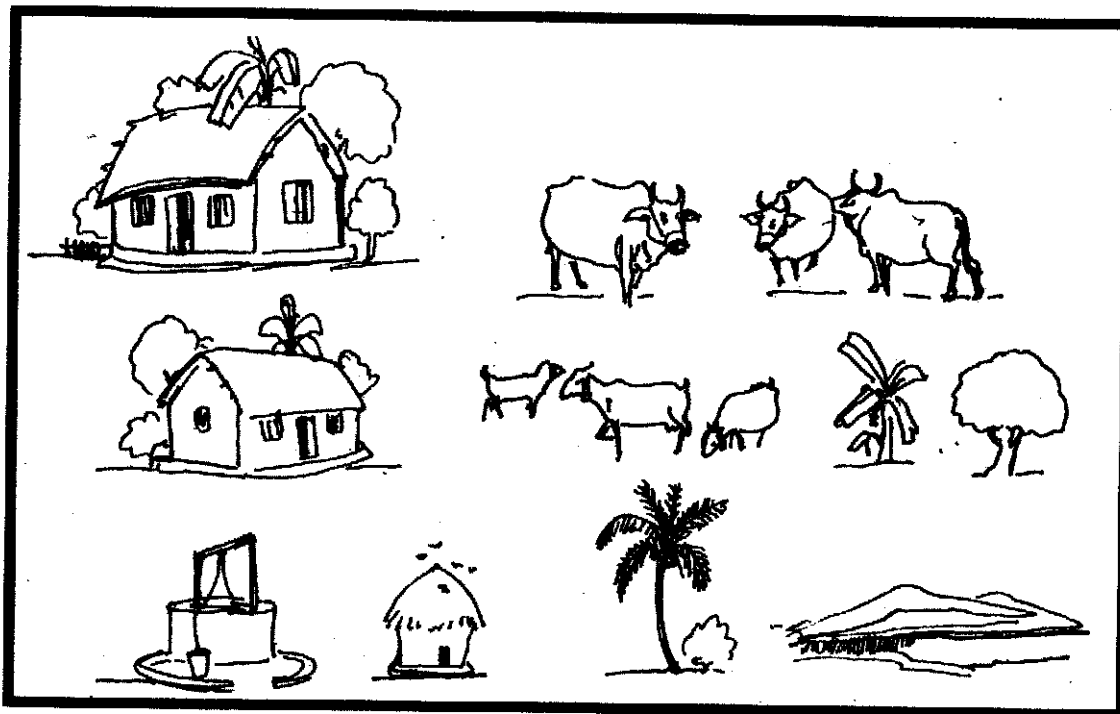

Fig. 4.5A

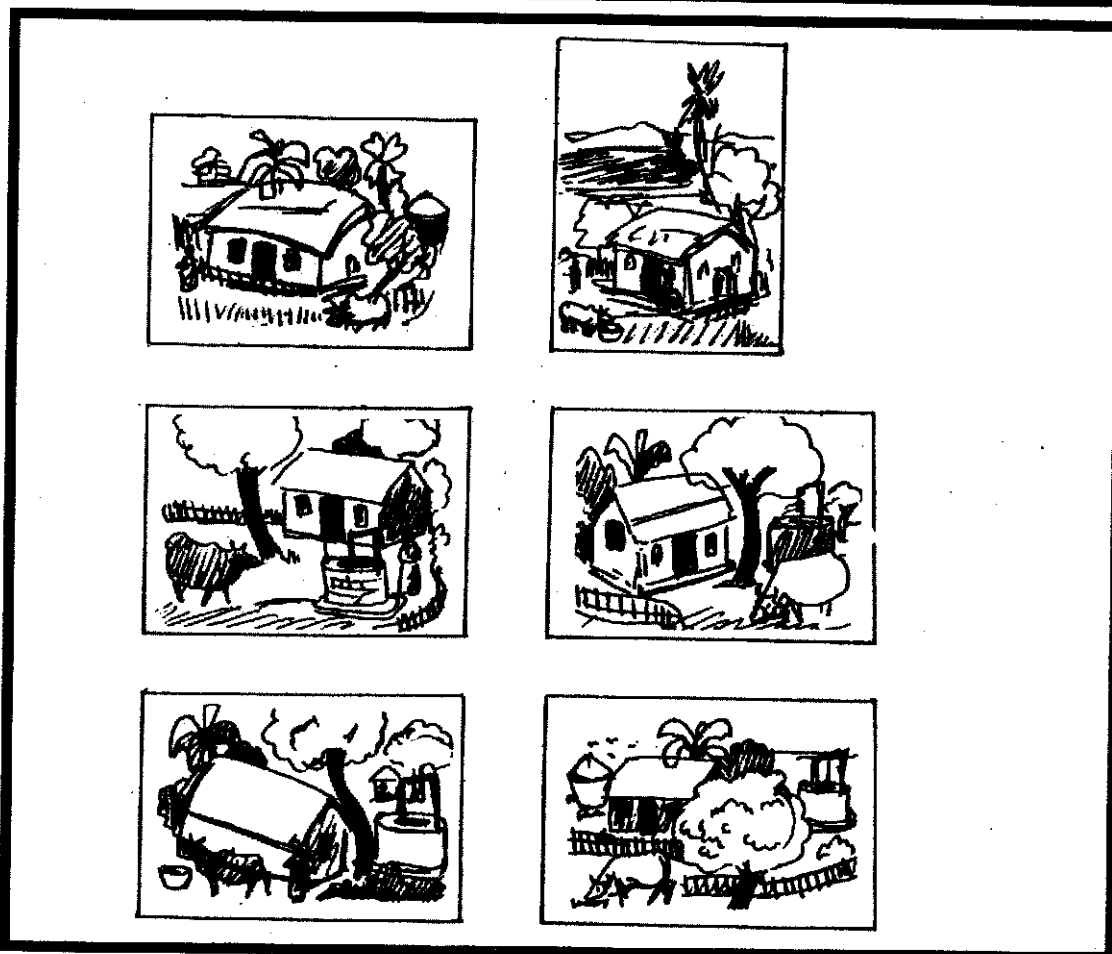

Fig. 4.5B

#### 4.5 USE OF VIEW FINDER

To make a static subject one can take the help of view finder - like camera view finder. Take a post card size blackboard. Make a 1" x 1 1/2" hole. This will help you to compose the objects and as you see through the hole, you may move the card right or left, upwards or downwards - keep watching to get a suitable composition. (See Fig 4.6).

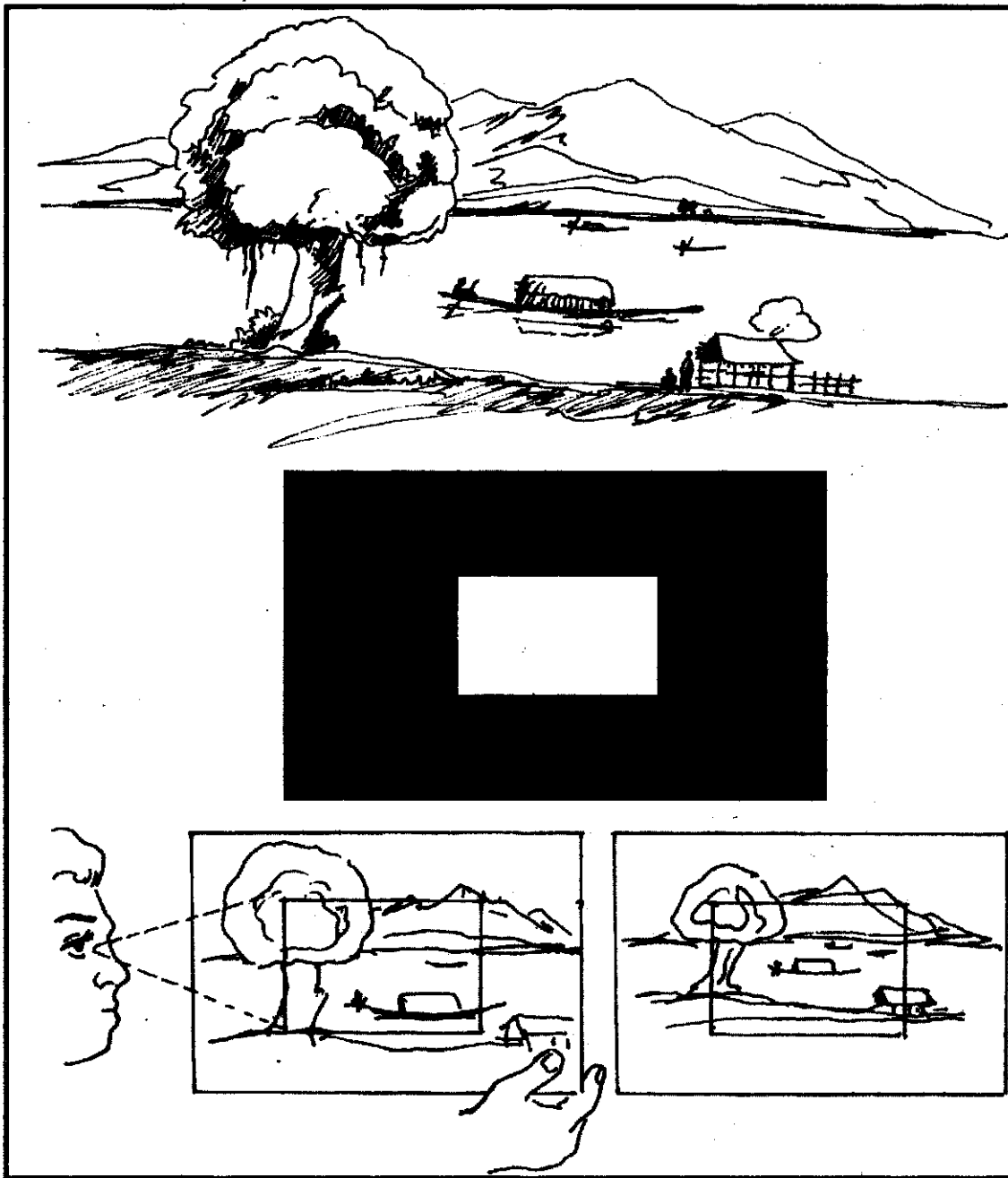

Fig. 4.6

#### 4.6 NATURE STUDY COMPOSITION

From Nature Study/sketches you can make composition. Suppose the subject is village corner. In your sketch book you have to make sketches of different objects around you like Huts, Boat, Trees, River, Hills, Birds etc. Indicate the colour tone of the object side by side.

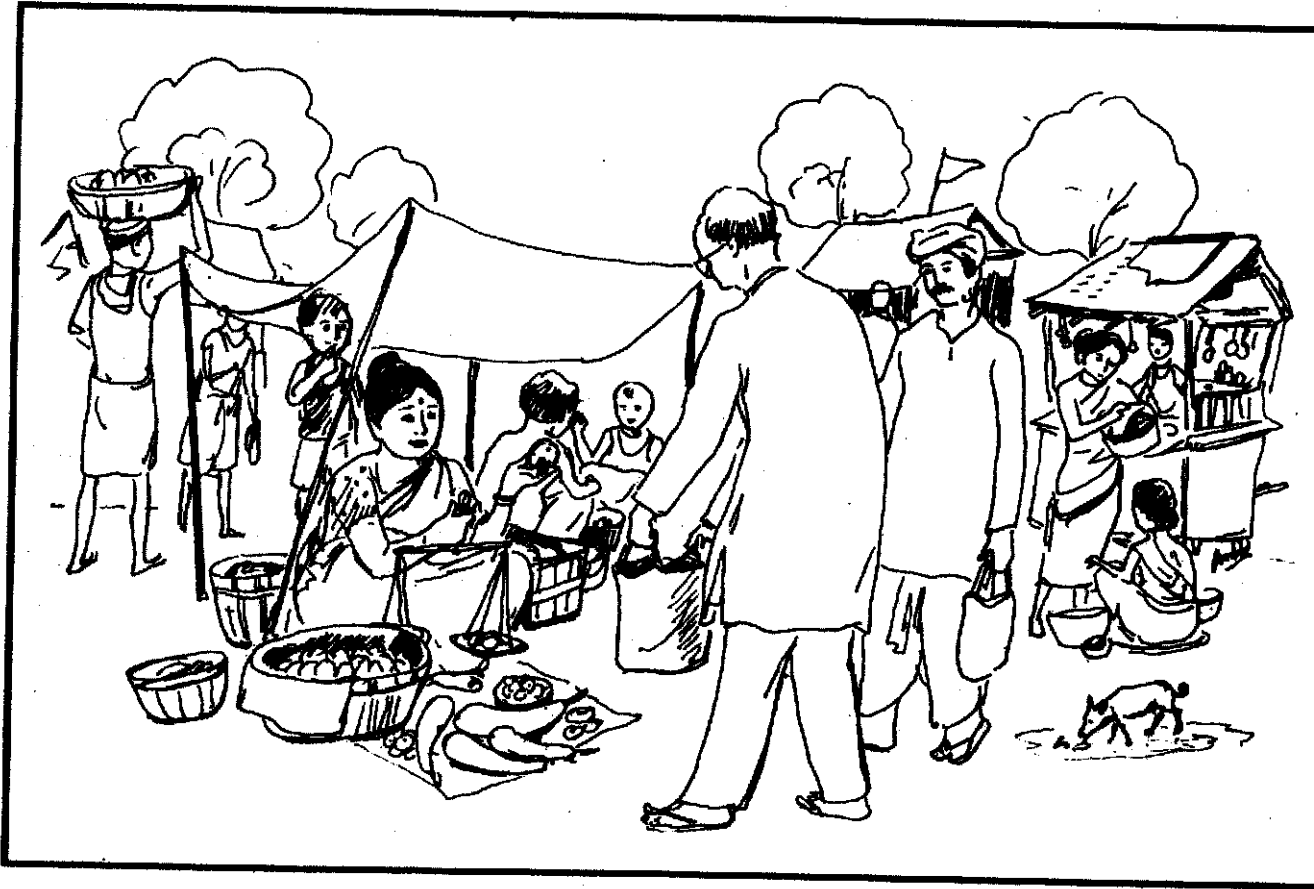

Fig. 4.7



This type of composition can be made in two different ways - spot painting or nature study, other one is composition from collected references/sketches which may call landscape composition.

When we take a photograph of a spot or scene, we cannot change or eliminate any object. But in the case of painting this is possible. At the time of preliminary sketching we can change, eliminate or replace any object, which is not important or disturbing the composition to make the picture beautiful.

When the references are available, you can make few rough pencil compositions before making a final composition for painting, afterwards use colour.

#### 4.7 DECORATIVE FORM OF COMPOSITION - BASED ON NATURE (AROUND US)

You can make sketches from flower, leaves, flower buds, creeper even trees. This can be symmetrical pattern or a-symmetrical, but should cover the space nicely. This types of composition is different from normal composition for painting. Unlike painting composition this style covers maximum space. This could be colourful also, take the help of its natural colour scheme.

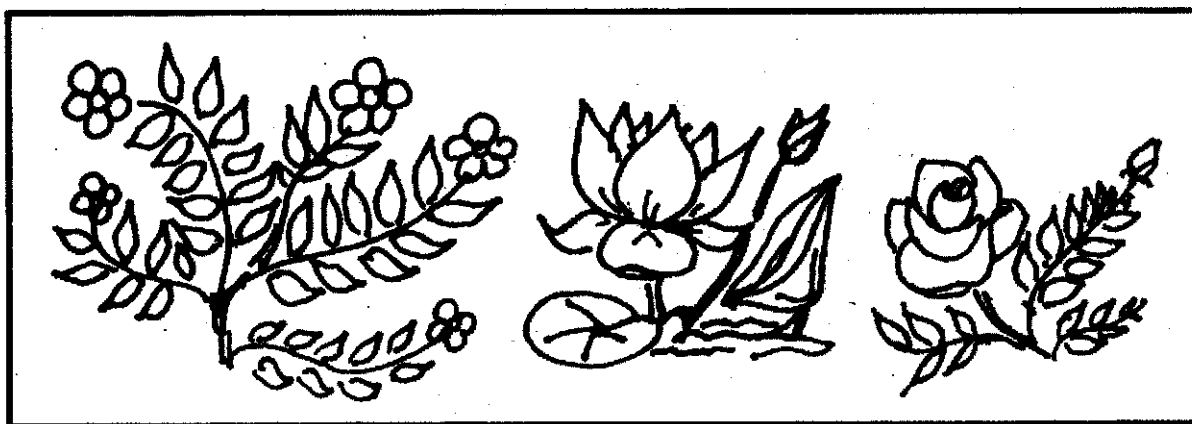

Fig. 4.8

#### 4.8 SUMMARY

To express the artists ideas or imagination properly in a painting is called composition. While sketching colours should be used properly adding light and shaded. First sketching can be done with pencil and afterwards the paintings can be drawn on canvas or paper.

---

#### 4.9 INTEXT QUESTIONS

---

1. Draw and compose the paintings of the following objects:  
Jug, Glass, Basket, Fruit, Flower
2. Cut one sheet of paper in different shapes and sizes - Circle, square, triangle etc., and then compose in geometrical form.



*Fig. 4.9*



*Fig. 4.10*



# Sketching from life and memory

## 5 INTRODUCTION

A book without picture and a wall without painting seems like a bride without ornaments. Sketch is the basis of drawing and painting. Sketch serves to drawing and painting as the back-bone to the body; to keep the body straight well-shaped and attractive.

Man is a social animal. He adopts one or the other medium to express his thoughts and feelings to others, such as writing, speaking, dancing, singing, and painting. A student expresses his ecstasy and sorrow by drawing lines at random. Then he likes to make pictures and paintings. Sketching is the first step to realize one's feelings and thoughts. In this lesson the different aspects of sketching are highlighted as to how to make it easy to make the shape and form of a thing through sketch, which will be very useful for the students. On the basis of the sketches given in this lesson, by practicing he can develop his imagination, creativity and his skills.

### 5.1 OBJECTIVES

After studying and practicing this lesson, the learner should be able to:

- draw the different aspects of sketching;
- explain and make the shape and form of a thing through sketch.

### 5.2 DEFINITION OF SKETCHING

Sketching is a pre-stage of drawing where the artist draws with a free and unassisted hand, that is to say, with no reference marks to suggest the outlines limits, no grip to help proportion, no system of measurement as a crosscheck during the progress of the work.

See the sketches of famous artists on the following figures (Fig. 5.1, 5.2)

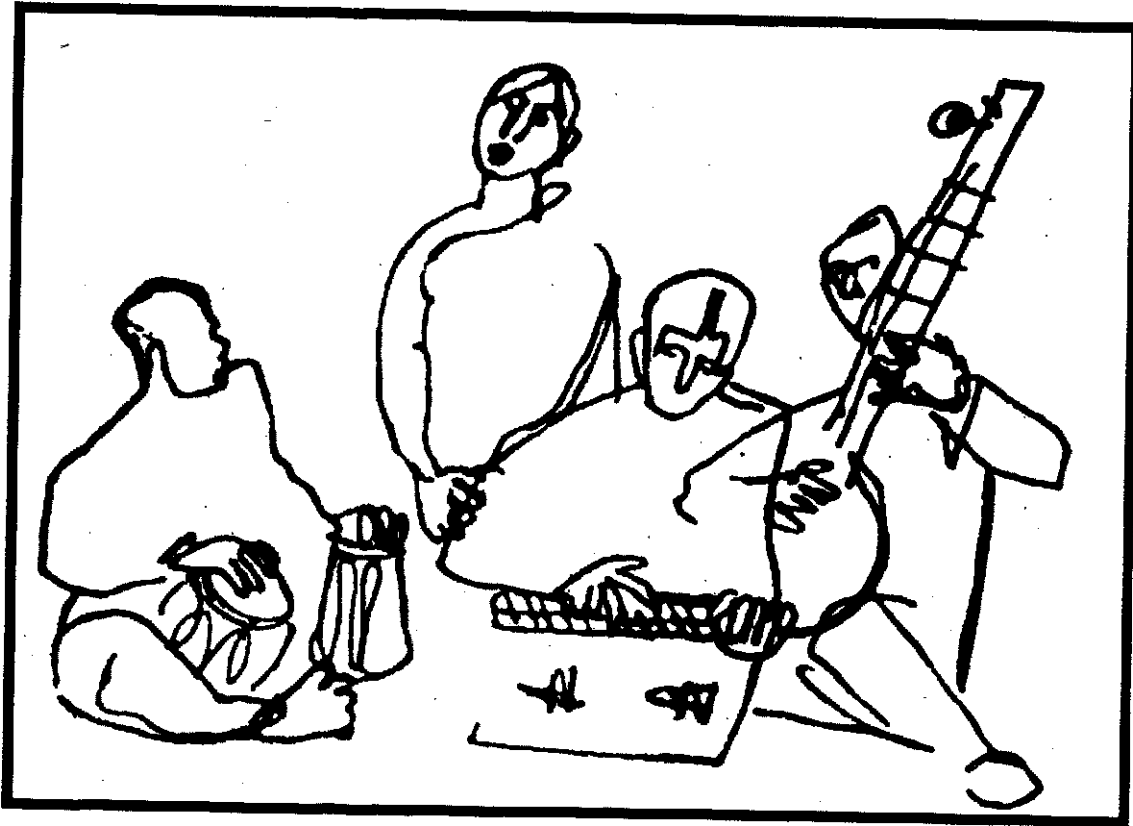

Fig. 5.1

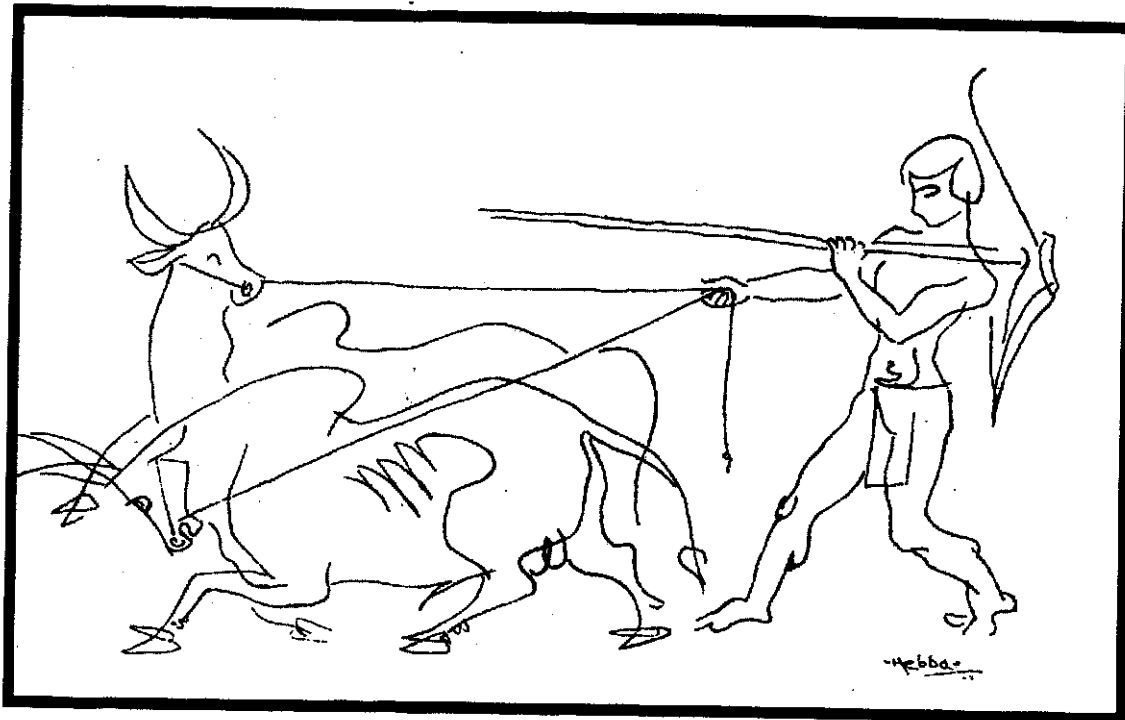

Fig. 5.2

### 5.3 DEFINITION OF DRAWING

Drawing is a way to arrange the world visually. Drawing is a means of recording what one sees and experiences in the world around oneself. We use drawing to work out ideas and analysis of it leads to seeing and understanding.



*Fig 5.3*

### 5.4 BASIC MATERIAL

The first step is to collect the following tools and other material for sketching:

- **Drawing board:** Any rigid and smooth surface or plywood or hard board.
- **Paper:** For practice session, cartridge paper or any plain paper can be used.
- **Eraser:** Soft rubber of good quality should be used. It should be used very sparingly to erase incorrect drawing or superfluous lines.
- **Pencil:** An HB, 2B, 6B, and Charcoal pencil should be used. The lead should be blunt at the point at the time of sketching.
- **Clip:** A clip is useful to hold the pad or loose paper to your drawing board.

## 5.5 METHODS OF SKETCHING

- **How to hold a pencil:** Holding the pencil wrongly is often responsible for deep and rough lines resulting in spoiling the paper. The difficulty arises, mainly because students are accustomed to writing and writing causes for the direct movement of the fingers, while in drawing with a pencil, the movement comes from the wrist and the hand. The pencil should be held firmly from two inches from the point of the pencil. This distance will vary according to the size of the hand and the length of the line to be drawn.
- **Importance of lines:** It is necessary for the learners to practice to draw lines of different types. It will help to provide movement and sharpness while sketching. The important lines are horizontal, vertical, diagonal, and spiral etc. These lines are shown on the references of sketching as guide-lines for practice.
- **Understanding of Proportion:** A comparative relation between two things is called proportion. While sketching, it is necessary to see the human form, animals, birds, flowers, leaves, mountains and jungles in proper proportion. To place the figure properly on the page seems both simple and obvious but learner should bear in the mind the basic proportion of the human figure and object. The ideal or standardized proportion of the human body is approximately seven and a half heads high. Take the head from the crown to the end of the chin as a unit of measurement. Height of the people is affected by native and geographical condition. (Fig. 5.4A, 5.4B)

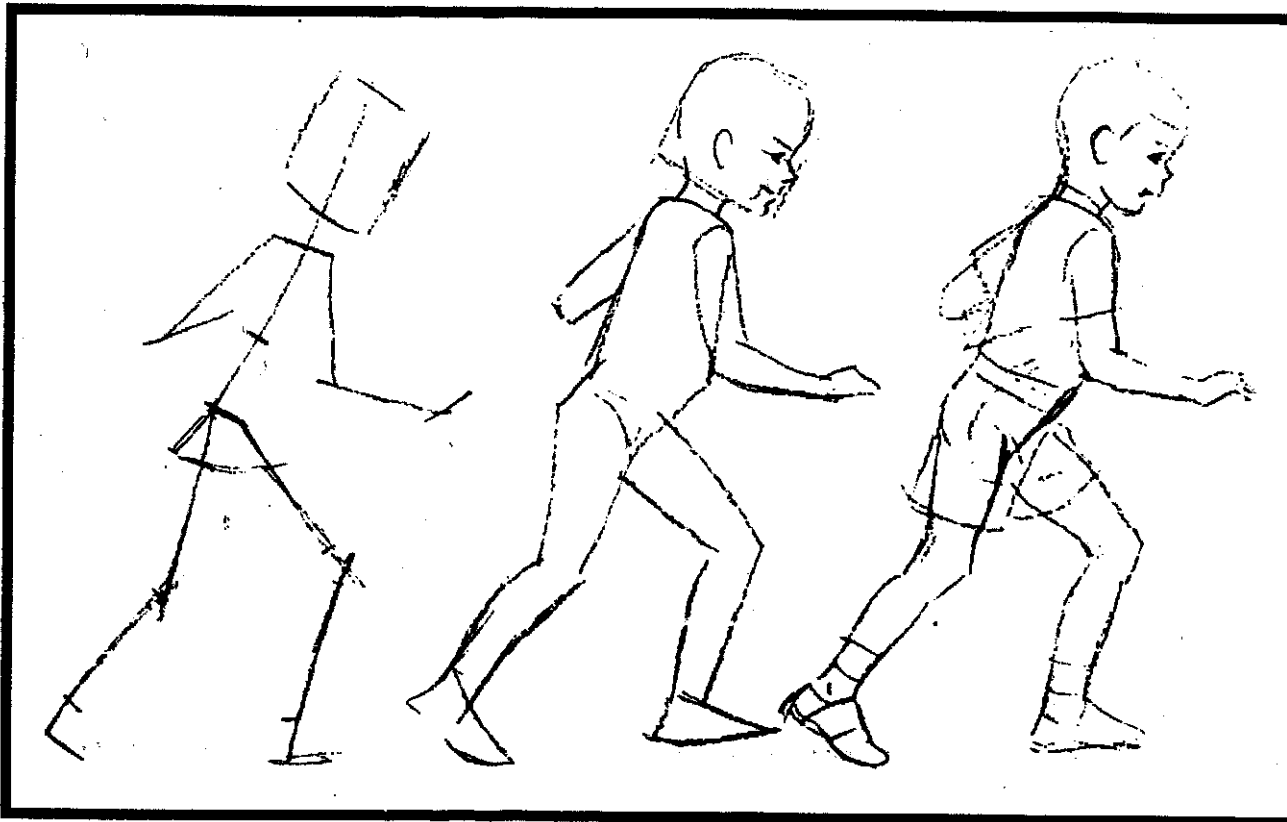

Fig. 5.4A

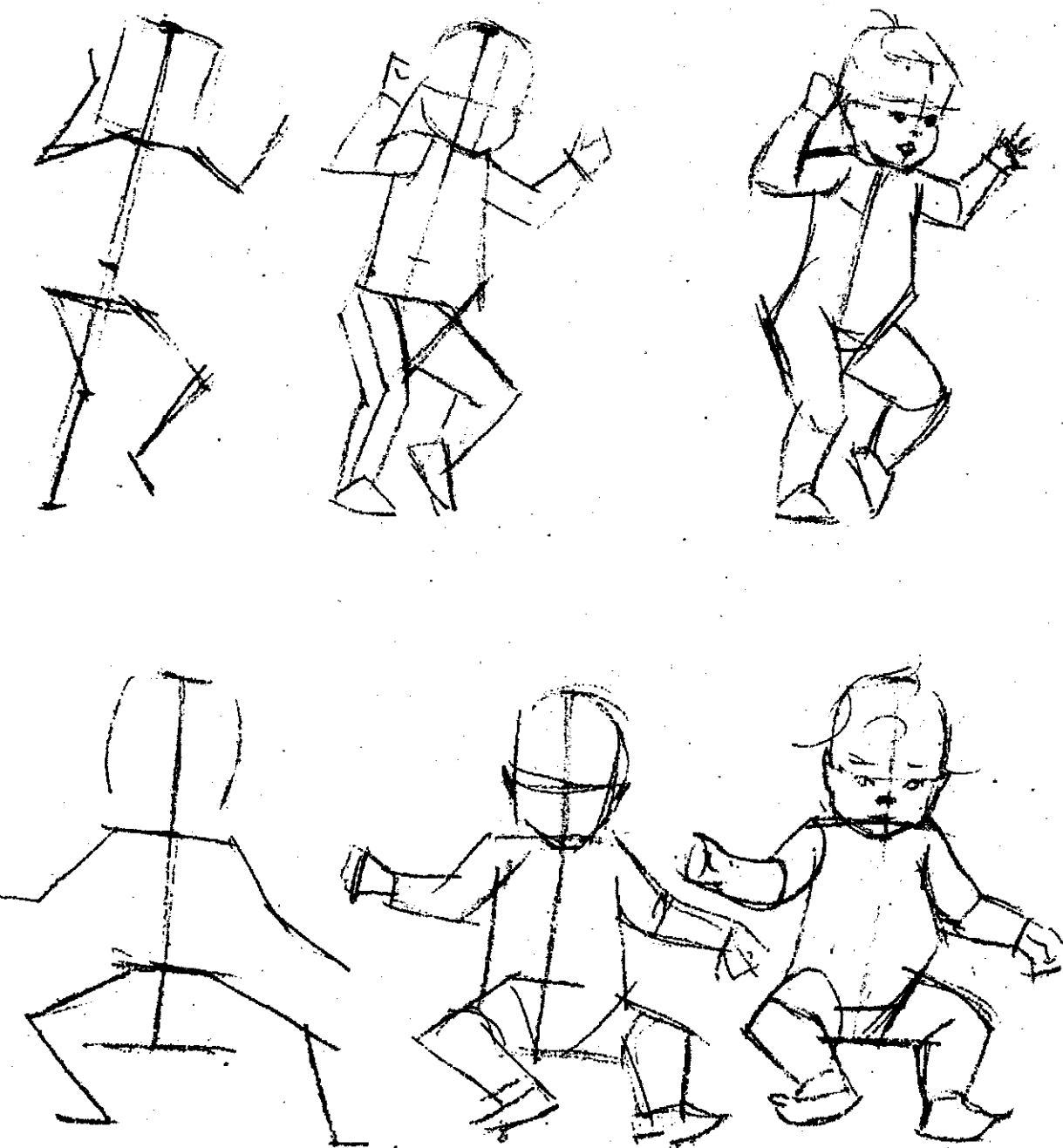
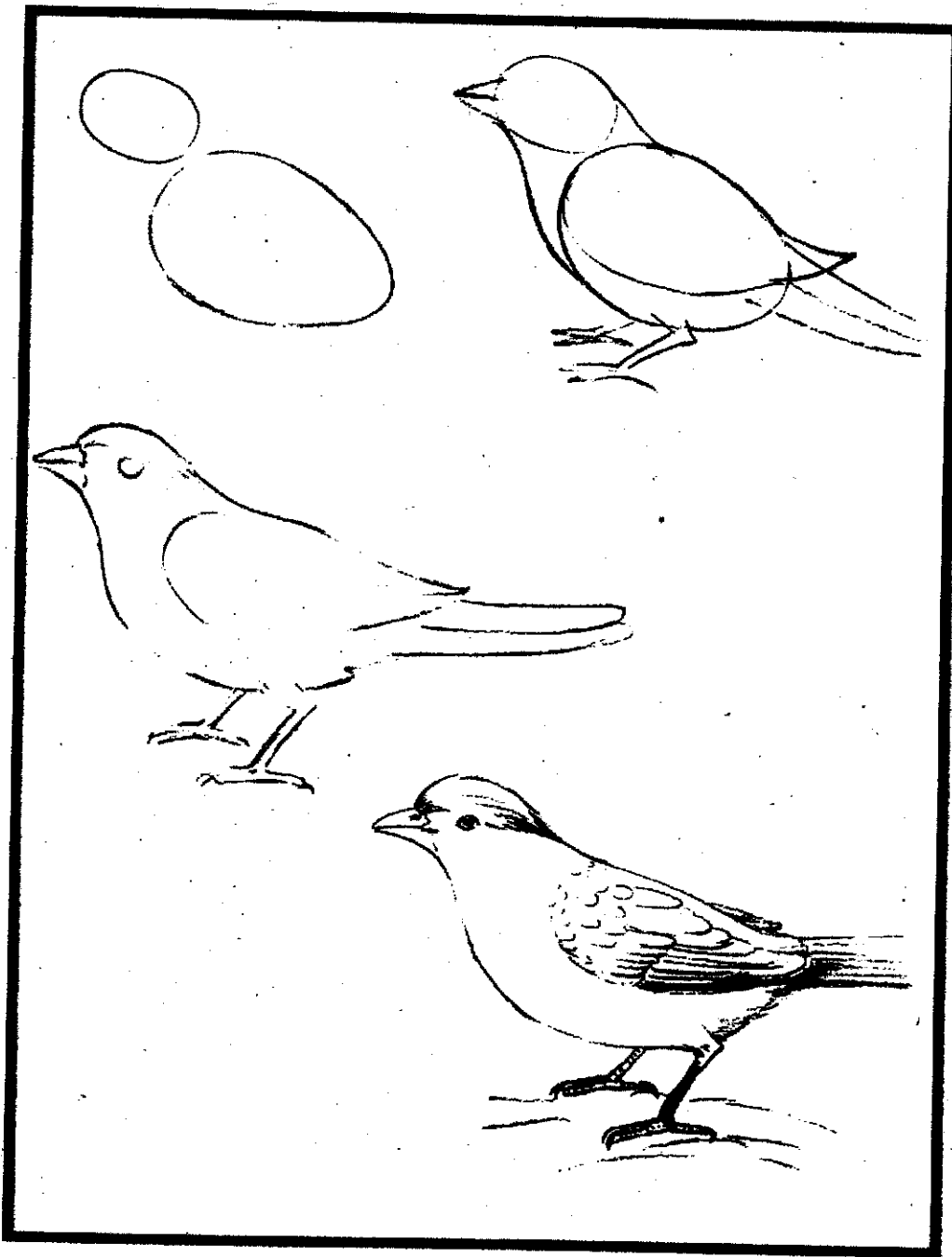

Fig. 5.4B

- **Placing the Object:** Sit fairly close to your object and focus your eyes on some starting point along the contour (outline) of the object placing your pencil on the paper. Imagine that your pencil point is actually touching the object. The pencil can be held lightly. Use a simple block- construction methods shown on the reference of sketching at his stage. (Fig. 5.5A, 5.5B, 5.5C, 5.5D)



*Fig. 5.5A*





*Fig. 5.5B*

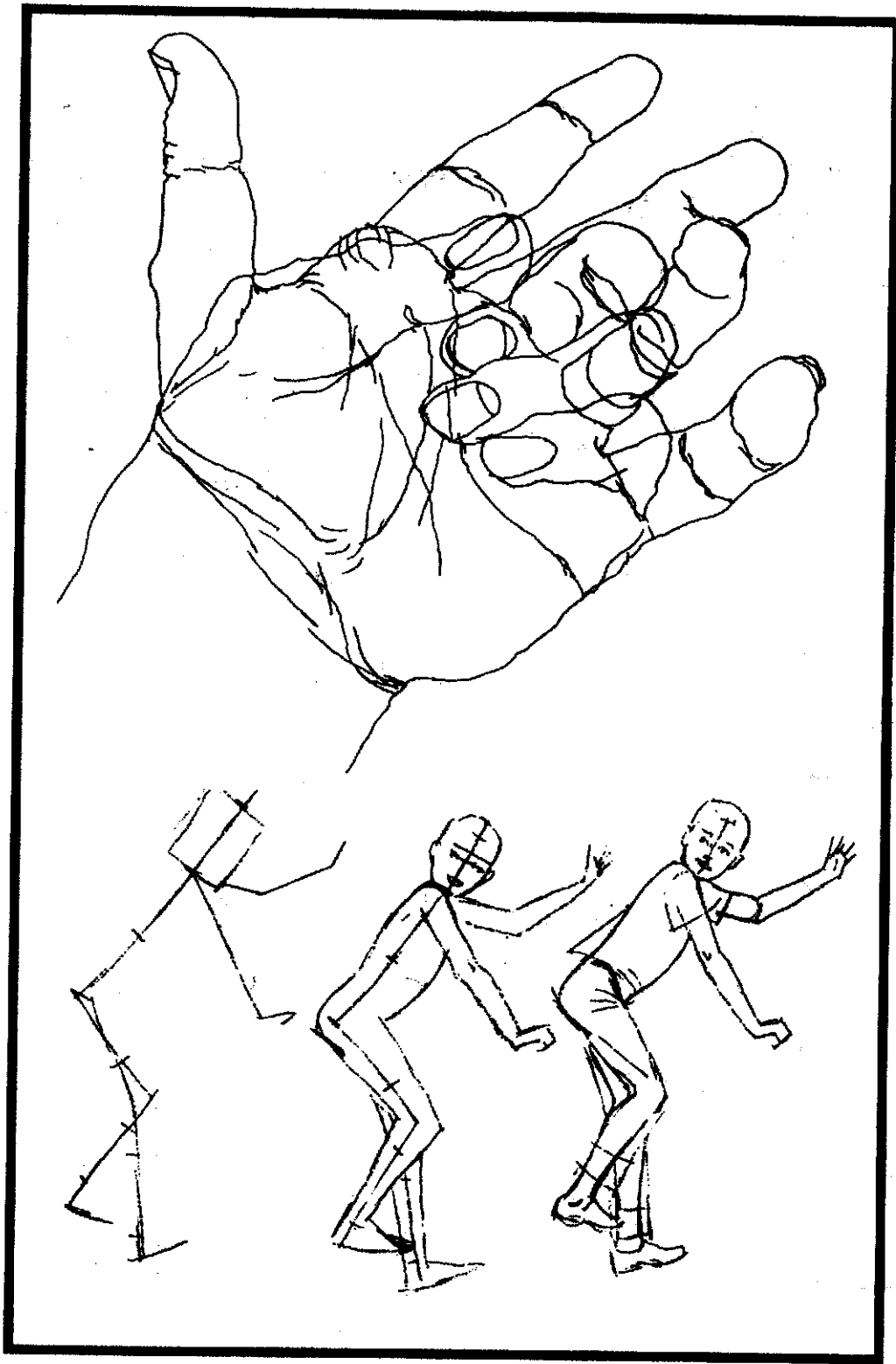

Fig. 5.5C

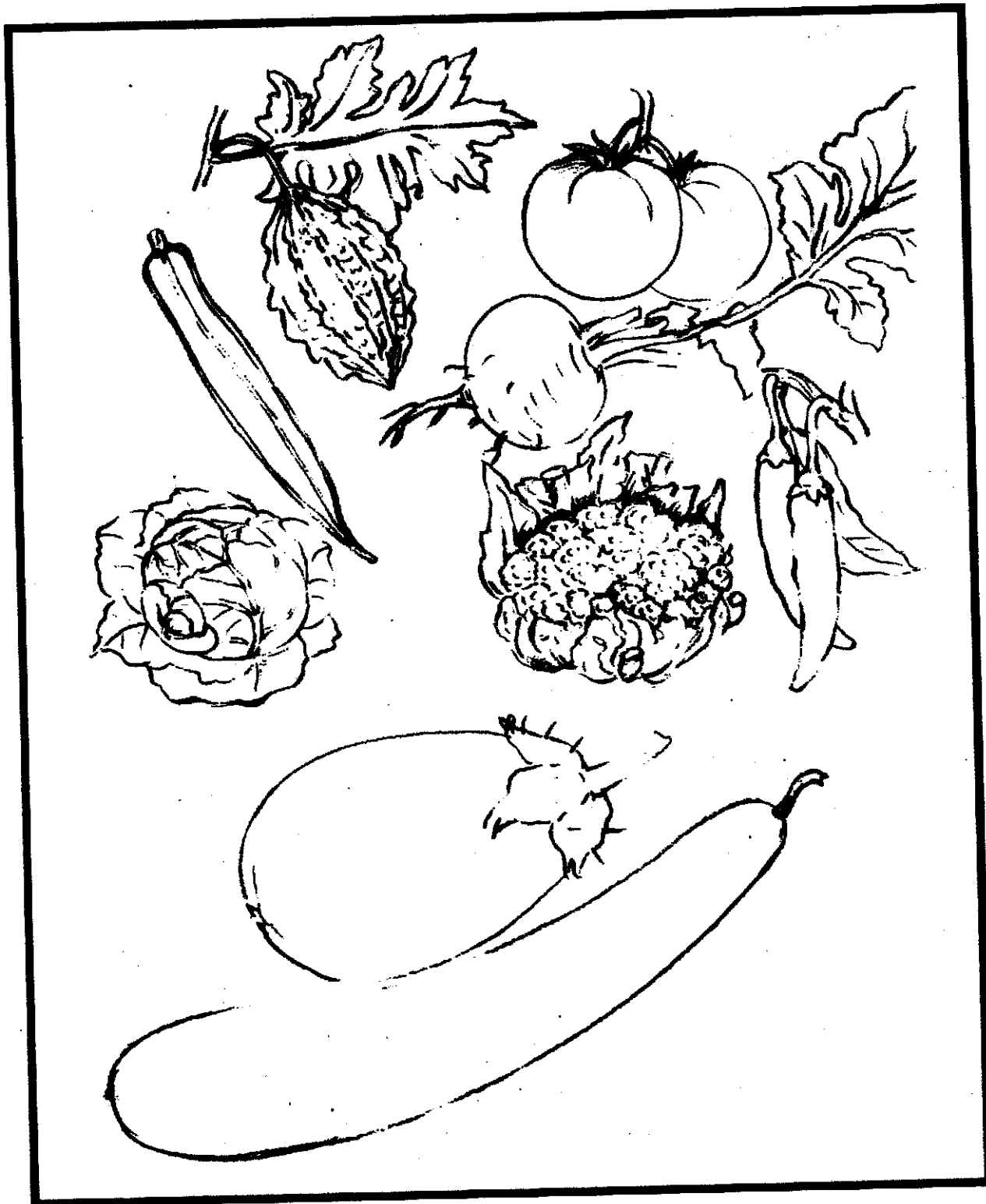
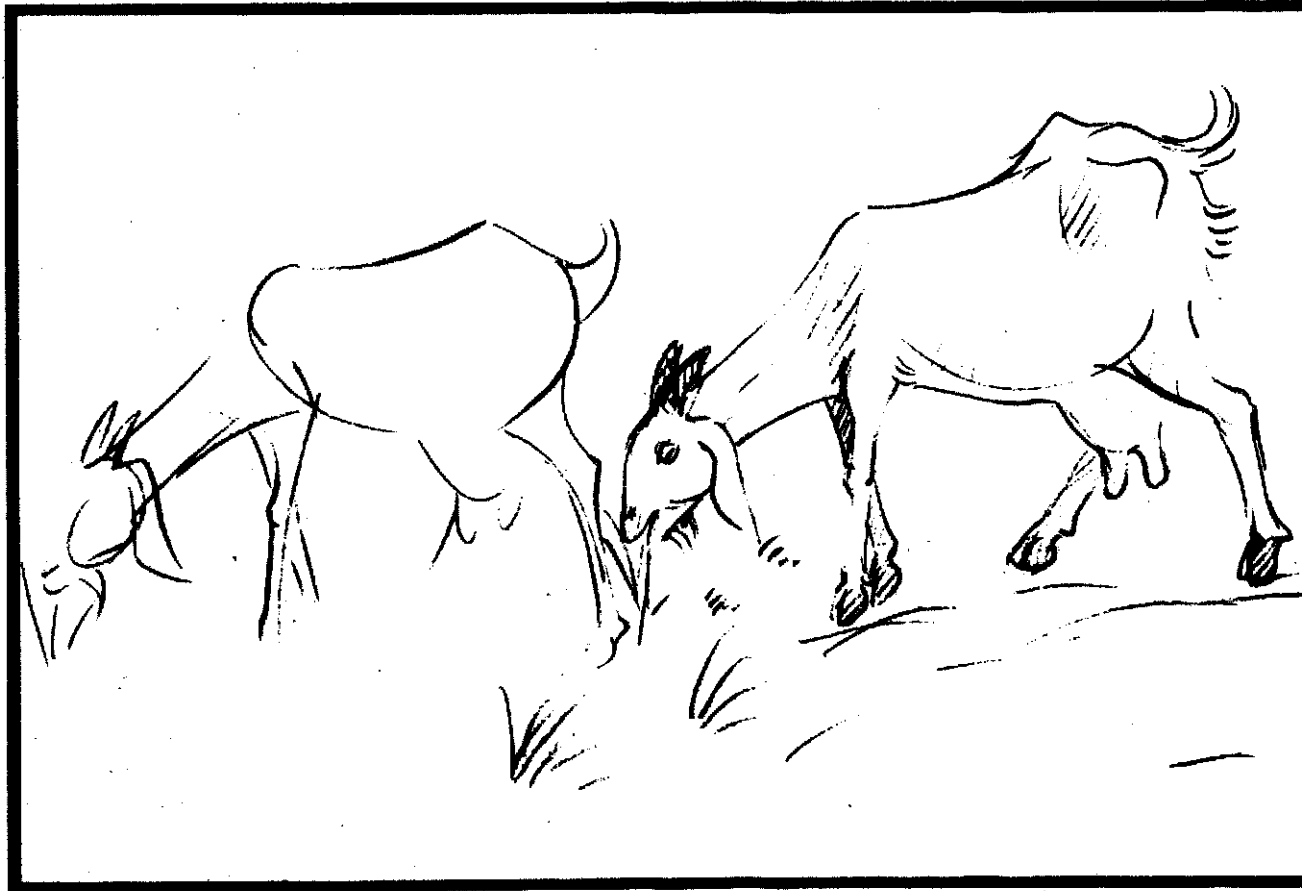

Fig. 5.5D

## 5.6 SKETCHING FROM MEMORY

Students prefer to draw entirely from memory even if they are told to sketch by viewing only. They will put something from their vague recollection of the object. This will be a creation rather than copying because they are able to transcend the object in their own way through memory. (Fig. 5.6, 5.7, 5.8 and 5.9)

Suppose if you have to draw a tree or any animal from memory, first see it and close your eyes and imagine the shape through the eyes of mind. How it looks? This will improve the observation and unfold your creativity.



*Fig. 5.6*

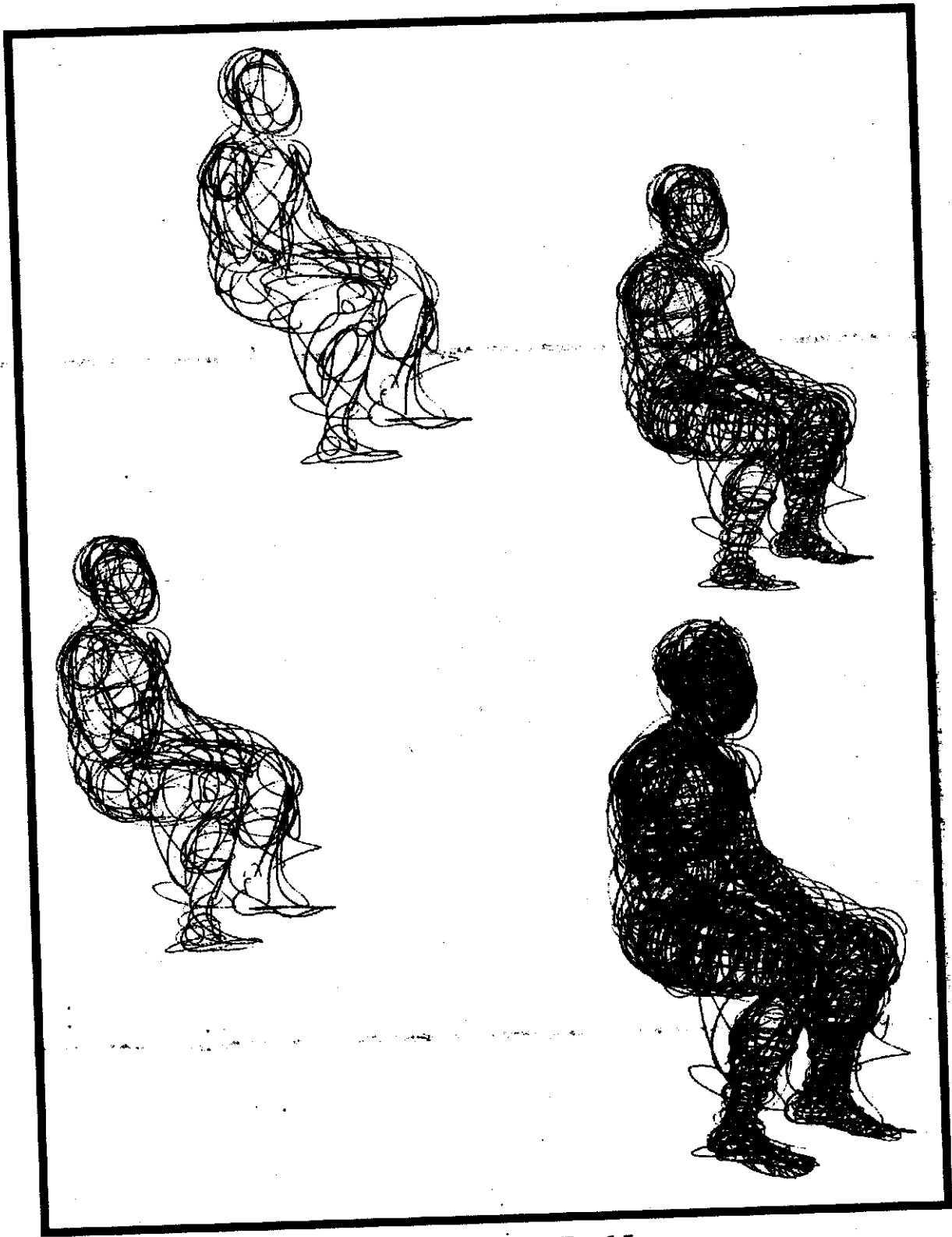

*Fig. 5.7*

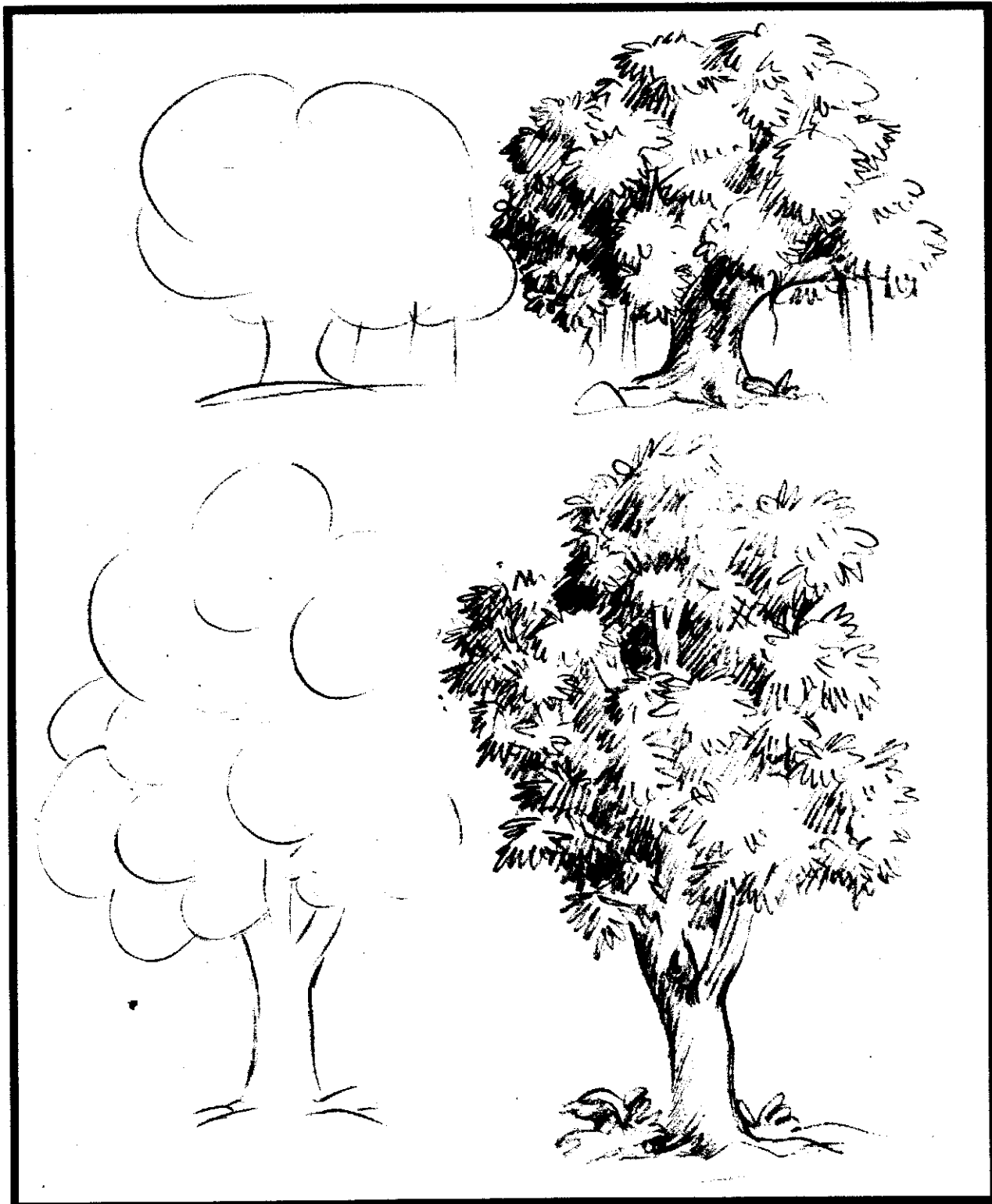

Fig. 5.8

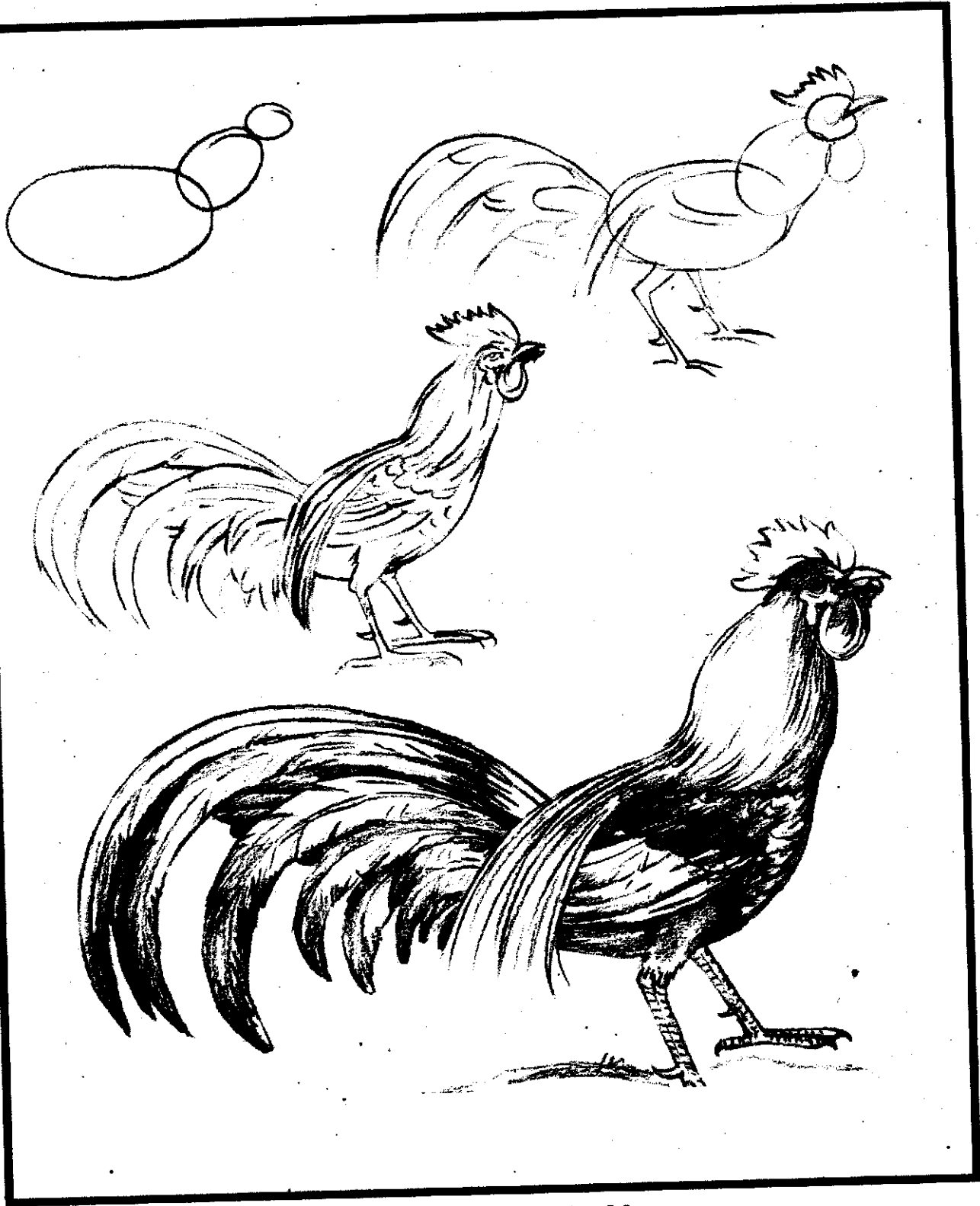

Fig. 5.9

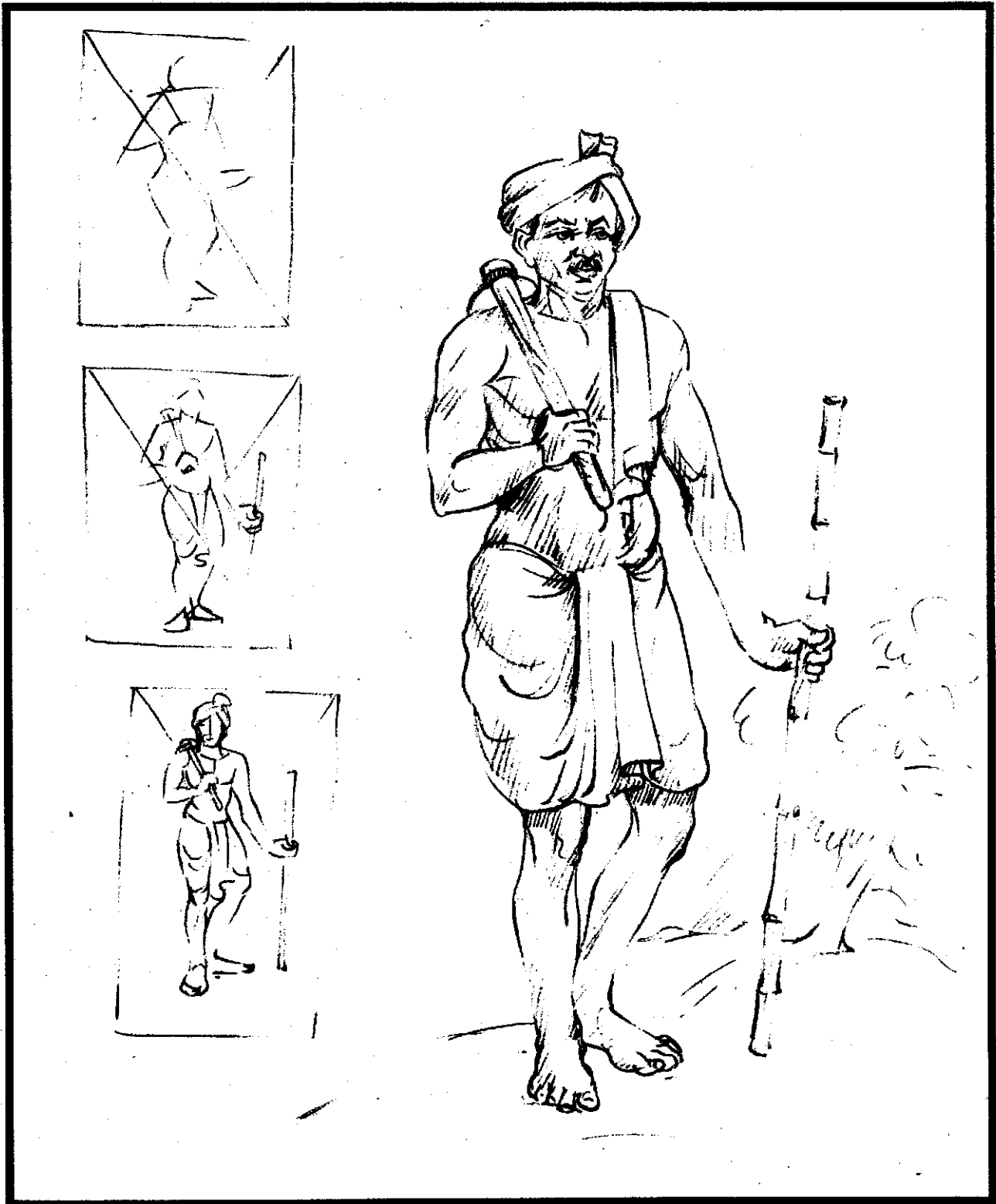

Fig. 5.10



## **5.7 SUMMARY**

Sketching is the first step to realize one's feelings and thoughts. By practicing the learner can develop his/her imagination creativity and his/her skills. The basic material required for sketching include drawing board, paper eraser, pencil and clip. The learner should know the methods of sketching such as how to hold a pencil, how to draw lines of different types, seeing different objects in proper proportion, placement of the object and sketching from memory.

---

## **5.8 INTEXT QUESTIONS**

---

1. Make a composition of sketches of vegetables.
2. Do practice of human anatomy from given sketches.
3. Do sketches of your pet animals.
4. Observe some objects in your home and sketch them.
5. Draw the local market scene by your memory.

## **5.9 GLOSSARY**

Line - Line is symbolic mark denoting movement metered by our eyes.

Tone - Tone is a degree of value between black and white.

Form - The area which is covered by colour or line is known as form.

Space - Space is the volume occupied by form.



## Folk Art As Motif

### 6. INTRODUCTION

Art is the source of one of the most spiritual experiences. Unfortunately folk artists rarely think of themselves as artists, because they work outside the so-called tradition of fine art. A folk artist's main urge is to embellish the environment or to express a deeply felt belief. India is very rich in the tradition of folk art, which is more than five thousand years old. India presents innumerable varieties of folk art which are spread over this huge country.

A brief introduction will be given about popular motifs of Indian Folk art in different parts of this country.

Folk art is the priceless treasure of our country, which is continuing for generation after generation. These are part of every event, celebration and rituals of our life, viz-marriage, birth, etc. These artists create beautiful art effects, paintings, toys with the help of very simple home-made materials and instruments. Paintings are mainly done on the floor, wall and court yard besides paper and cloth. Colours are prepared from locally available vegetables and minerals.

Each and every state of India has its own style of Folk-forms. In fact, almost every district of these states presents its own distinguished style (you can look for it in the region you live).

Indian folk artists use traditional motifs in their designs with little regional variations. These motifs are in the form of animals, birds, plants, flowers and symbols.

Floor decoration or “Alpana” is a good example to illustrate the variation of motifs in different regions of India. It is called by different names also. Floor decoration is known as “Alpana” in Bengal “Osa” in Orissa, “Chauka Purna” in U.P., “Mandva” in Rajasthan, “Pepari” in North India and “Kolam” in the South India.

### 6.1 OBJECTIVES

After studying and practicing this lesson the learner should be able to:

- draw and compose traditional motifs, designs and forms
- handle local or modern colours to create traditional designs and motifs.
- draw an Alpana and Rangoli independently.
- draw and use traditional colour combinations for their motifs and designs.

### 6.2 EXERCISE

Some motifs are shown in the following pages. These are both floral and geometrical. Geometrical motifs are created with simple dots (.) and diagonal lines. You can draw and paint these designs on greeting cards, cushion covers, Sarees, etc. Try to innovate new designs combining different motifs. (Fig No 6.1)

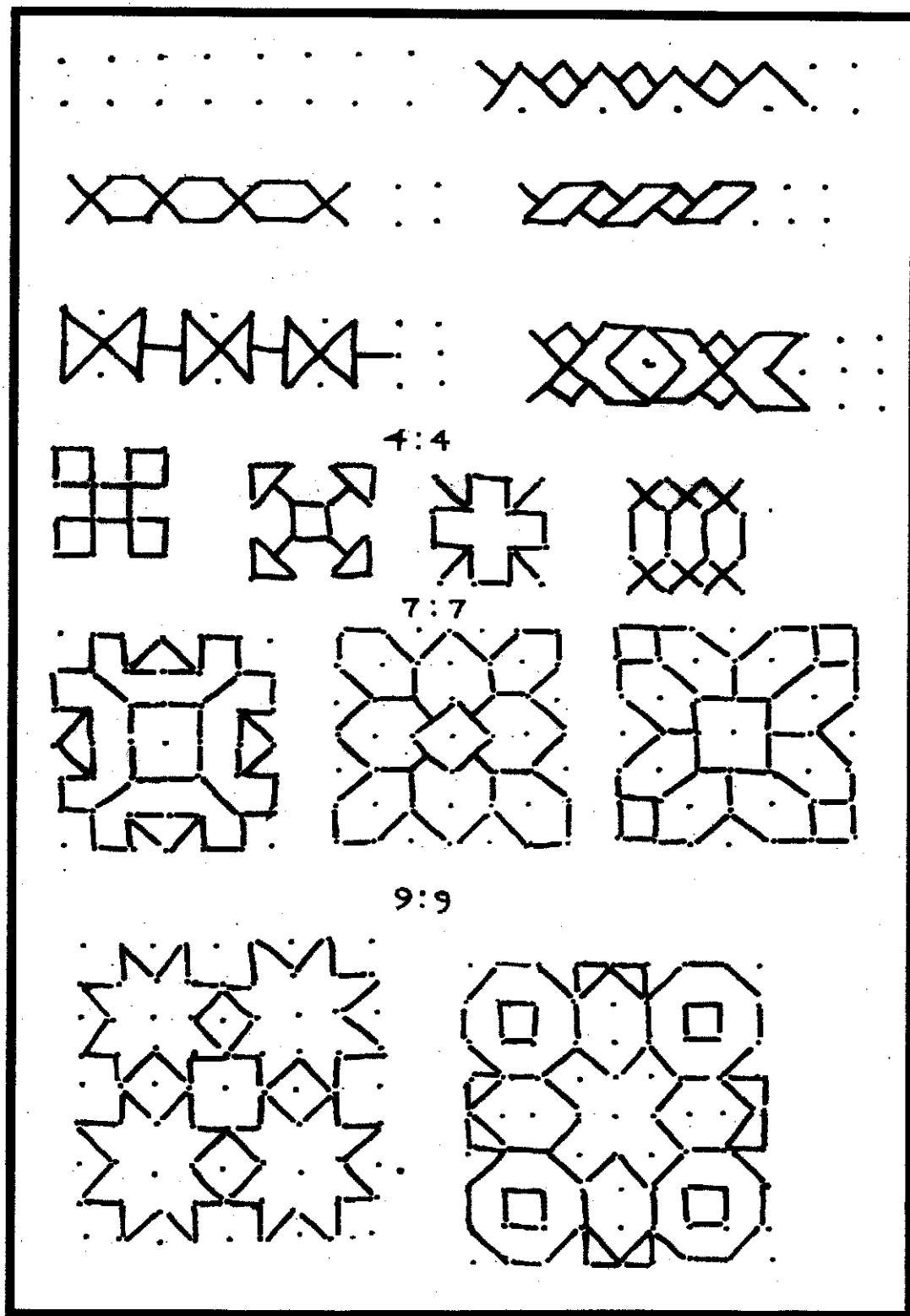

Fig. 6.1

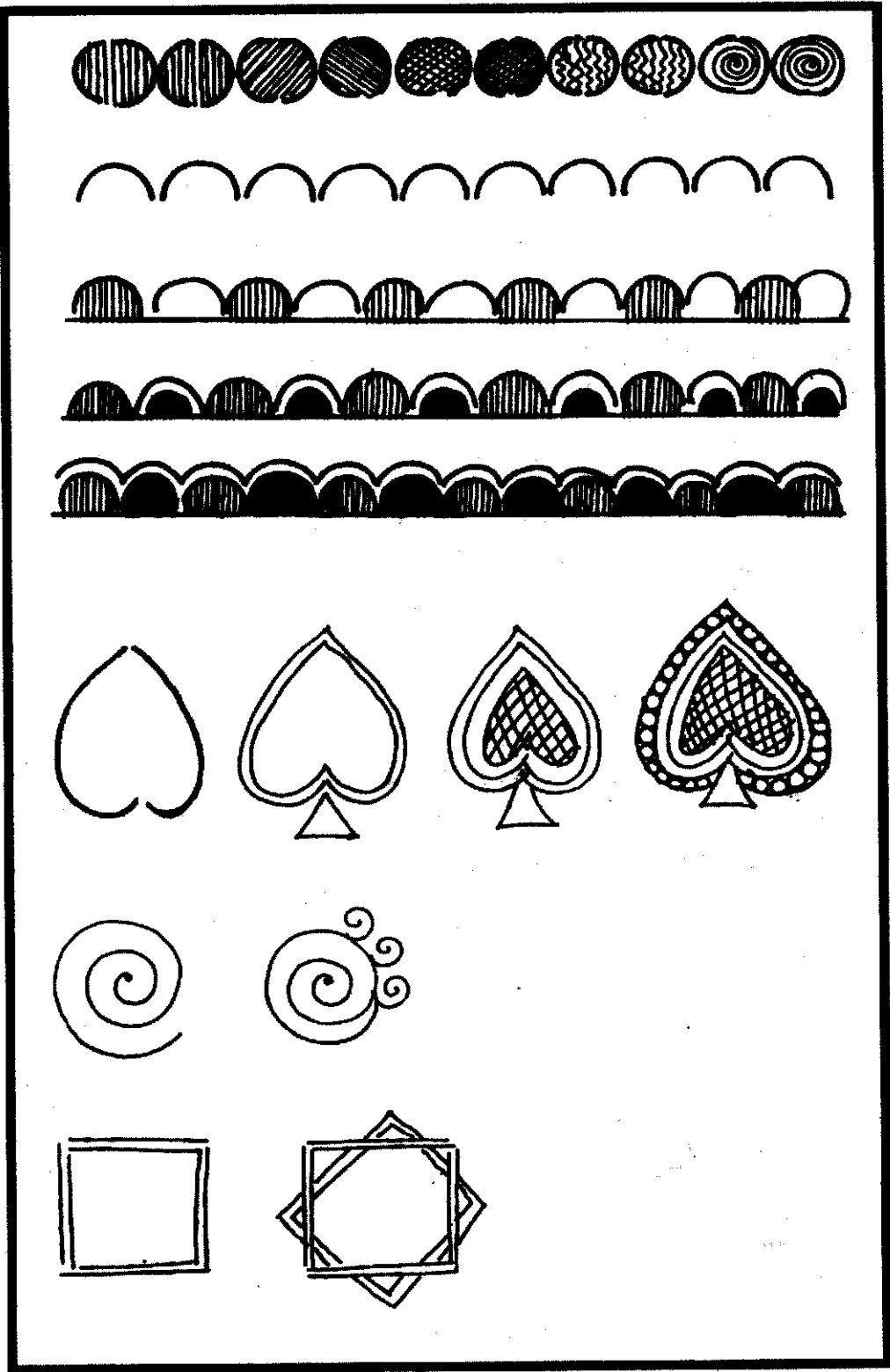

Fig. 6.2

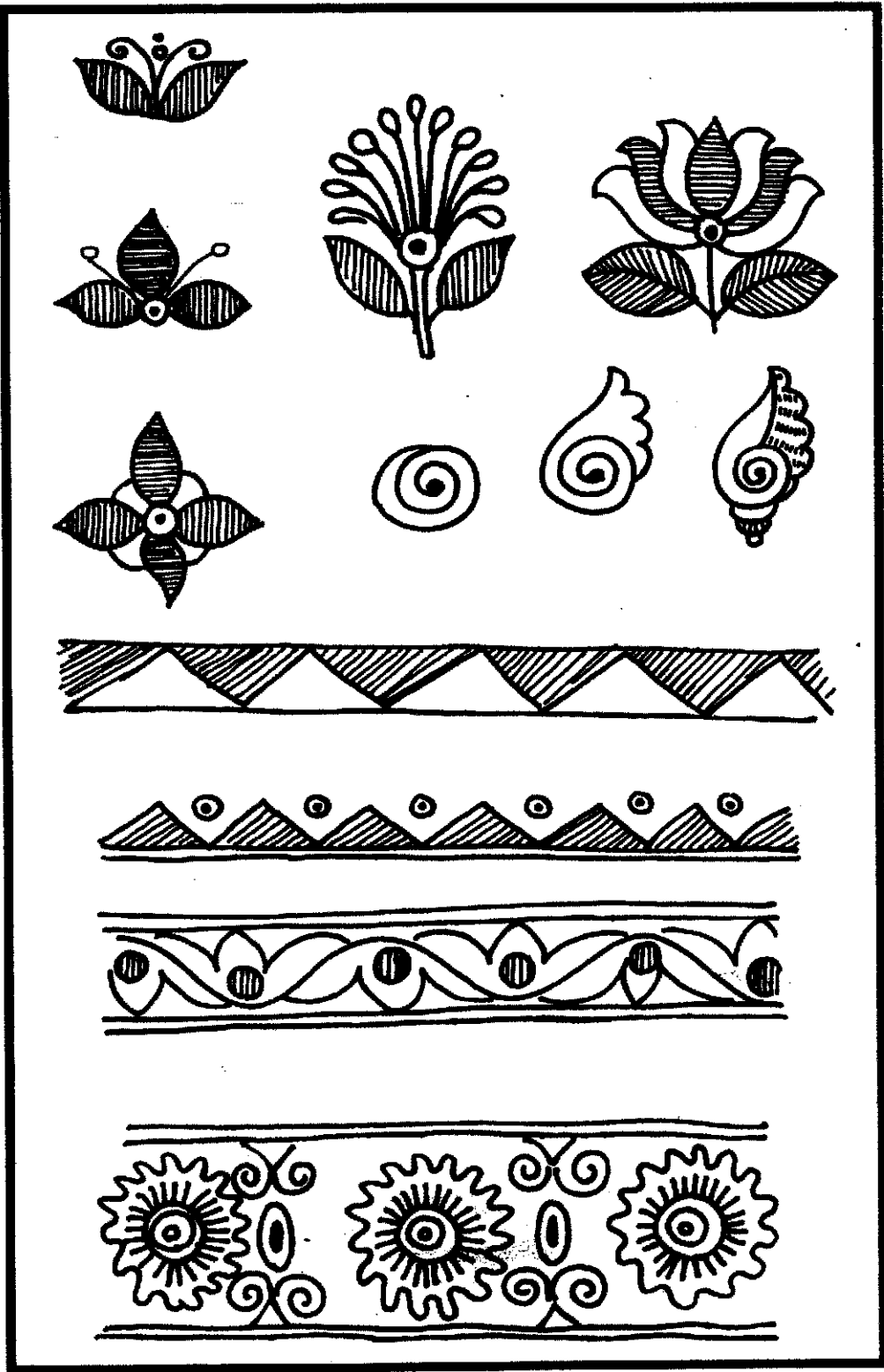

Fig. 6.3

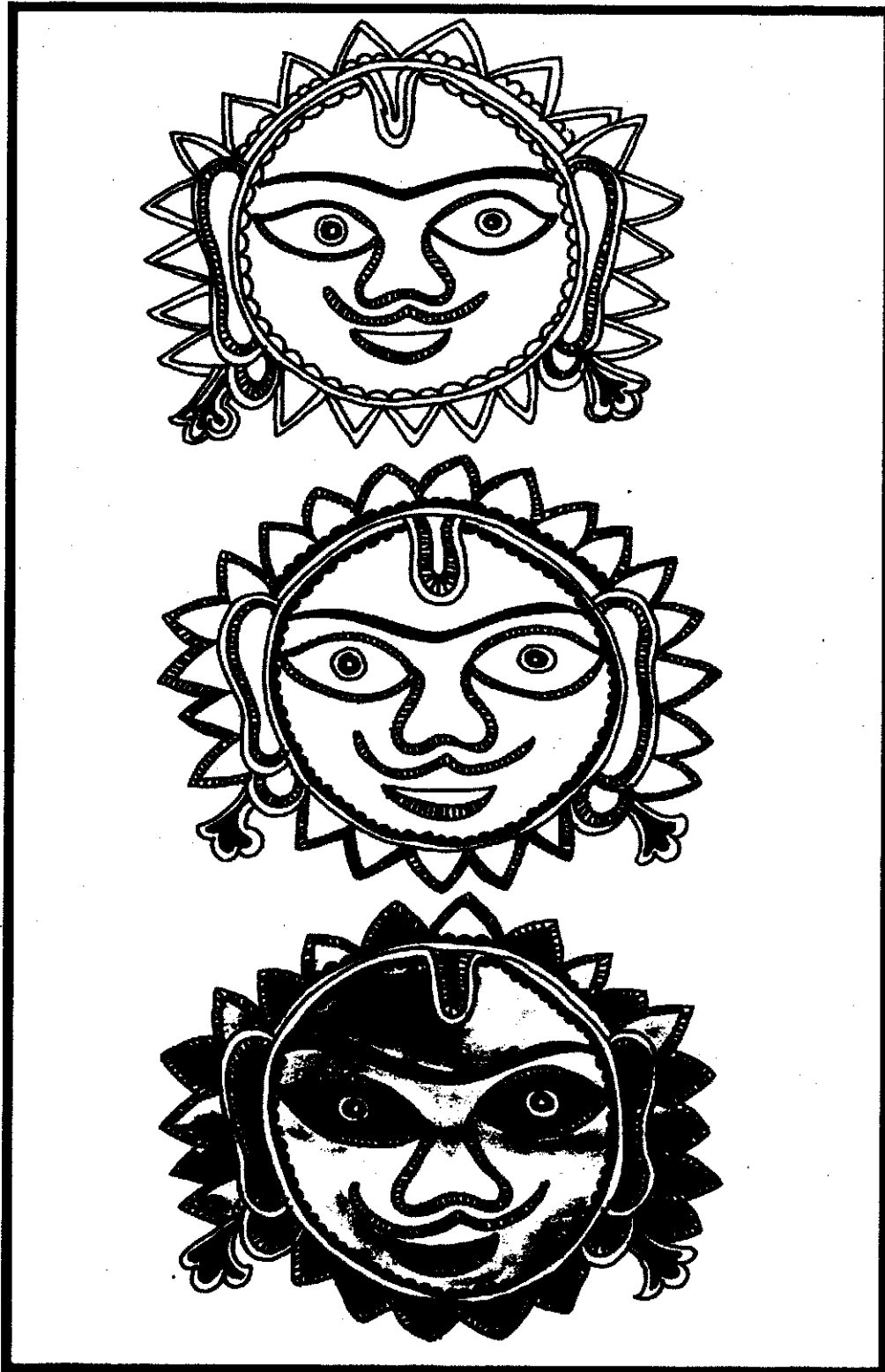
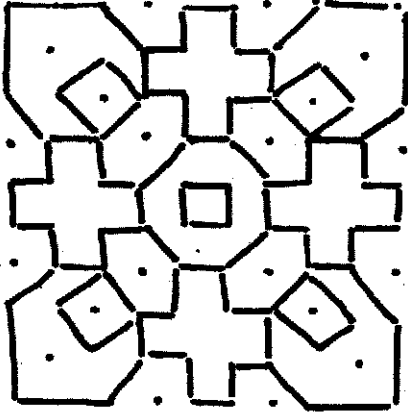
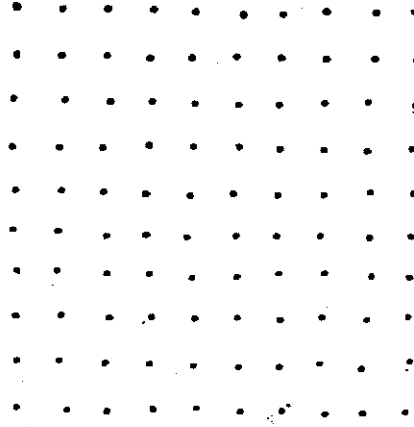

Fig. 6.4

10:10



10:10



10:10

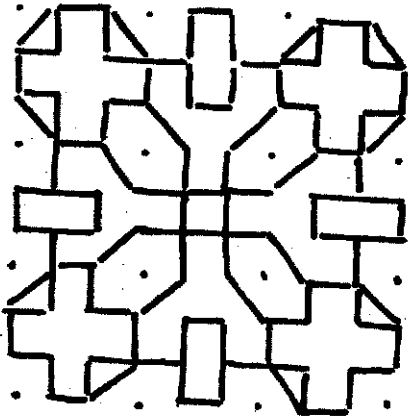

10:10

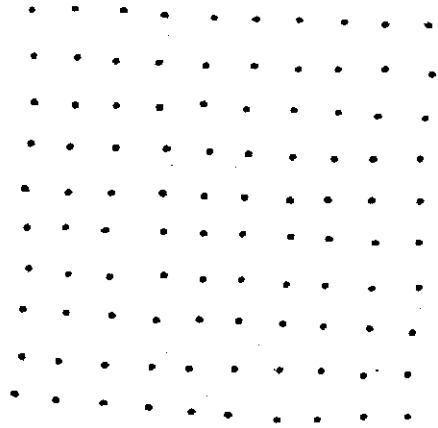

9:9

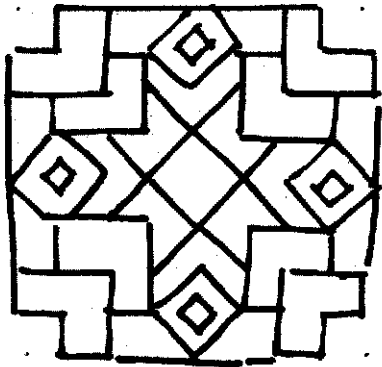

9:9



Fig. 6.5



# PRACTICAL

## Part I : Object Drawing

Study hours : 65

Marks : 20

- (1) Object Study
- (2) Nature Study

### Approach:

Awareness of Fundamentals of Drawing like *space, line, tone, volume, perspective, light and shade*, etc. through simple experimental exercises. Study of two or three simple objects including natural and geometrical be arranged together and composed on a given format either vertically or horizontally.

Simple objects based on geometrical shapes could include, for example, *jug, tumbler, basket, plate, bottle, kettle, vase, book, magazine, cup and box* etc. of a variety of materials like *terracotta, ceramics, cane, glass, paper, wood, plastic, drapery, leather and metal* etc. Natural forms locally available like *fruits, vegetables, flowers, leaves, twigs*, etc. are to be used. Select any two or three on given objects.

Materials to be used: Drawing paper-1/2 imperial size or (15 7/11" approximate size); Various grades of pencils (soft lead); eraser; colours- Oil pastels, water colours and ink; various grades of flat / round brushes;

## Part II : Painting and Composition

Study hours : 65

Marks : 20

- (3) Fundamentals of Painting
- (4) Composition
- (5) Sketching from Life and Memory

### Approach:

Free hand drawing directly from life of *Human Figures, Animals, Trees, Building, Interior of a Room, Bus stop, Market Place, Vehicles*, etc. Paint on a given topics like e.g. *Festival, Fair, Railway station, Man reading a book or newspaper, Playing with your pet, Eating out, Night scene, Rainy day, wedding, Gram Panchayat, Pollution, Library, Mother & Child* etc. using imagination and everyday sketches.

Starting with Basic Design and various Experiments to understand variety in forms and overlapping, their simplification, colour wheel, variety in colour, hue, tone and texture, rhythm and continuity in application, concept of far etc. all brought together meaning fully in a composition. (Select any one on given topics).

Materials to be used: Drawing paper-1/2 imperial size or (15 7/11" approximate size); Various grades of pencils (soft lead); eraser; colours- Oil pastels, water colour and ink; various grades of flat / round brushes;

**(6) Folk Art as Motif****Approach:**

In regional Folk, traditions art and everyday life go hand in hand. It is both diverse and deep-rooted in the minds of people of India. The genesis of this lies mainly in the religious and festival ceremonies, whether it is *Mithila Paintings from Bihar, Kalighat Painting from Bengal, Worli Painting from Maharashtra, Phad Painting from Rajasthan, Kalamkari from Andhra Pradesh and making of Alapana/ Rangoli etc.*

Select any one form of Regional Folk painting and utilize its visual imagery for creating a composition or design.

**Materials to be used:** Traditionally or locally available materials. Students will have to bring their own painting materials excepting the drawing sheet, which will be provided by NIOS at the time of examination.

**Port-folio submission Marks : 15**

Learners need to submit portfolio with minimum Twelve Original works, and one sketchbook, must include (sketchbook should include sketches from memory, nature and objects—animate and inanimate objects etc.)

*Concept of presentation, which includes dating, mounting and maintaining the work.*

1. **Four Object and Nature Studies** paper size- ½ imperial size or (15"x 22") approximate, with one in Line, (ii) one with Tone in pencil and two in colours;
2. **Four Painting and Compositions** paper size- ¼ imperial size or (15"x 11") approximate size, two composition in colours and two in mix media on any four topics which already mentioned.
3. **Four Regional Folk Paintings** in any traditional or locally available materials, (ii) paper size- ¼ imperial size or (15"x11") approximate.

**Sketchbook** (i) size 8"/11" or minimum 20 pages of any available paper, (ii) sketches in soft pencil. It should include all the sketches which you have studied so as to make your composition (figurative) and other studies like landscape, animal-birds, huts, flower, plants etc.

**Materials to be used:** Portfolio whether readymade or self made album from available materials.

# SCHEME OF EVALUATION

Mode of Assessment	Duration in Hours		Marks		Parts
Theory	15		50		1
Project (Group Project)	24				
Part A - Object Drawing - Isometric Drawing - Sectional View - Orthographic			5 5 5 5	20	1
Part B - Analytical Composition - Developmental composition including - Sketching of a subject (optional) - Colour drawing - Detail drawing	24	6	8 8 4	20	1
Part C - Book Review/View - Edition and Layout - Detail drawing	1		10 5	15	1
Portfolio Submission - Quality of work - Quality of work - Presentation		Self-paced	5 5 5	15	
<b>Total</b>		<b>54</b>		<b>100</b>	<b>4</b>

# 1

## Practical

**Aim :** To study and draw basic shapes and volume of objects in individual and groups.

### Introduction

Art will make us more sensitive to our cultural heritage, environment and develop a creative attitude in day to day activities. In the area of the art it is necessary to ensure that we should follow certain forms, techniques and styles. Therefore, practical part has very important role in Painting course. In every step you need to face experiment with easily available materials.

### Objectives

On completion of this Practical, you will be able to:

- differentiate basic shapes.
- to simplify different objects into basic shapes.
- create volume by using different line, light tone and shade.
- identify and treat the different size and proportion of the various objects.

### Select

- Cut three basic shaped hard paper (Post card, Copy Cover)

For Example

Circle

Square

Triangle

- Select 3 objects based on each shapes and place them in front of you and draw. Now convert these shapes into objects.

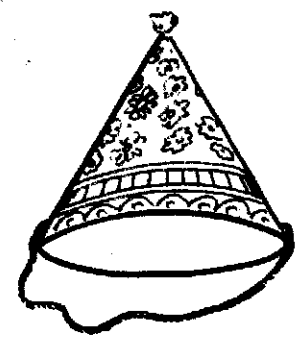
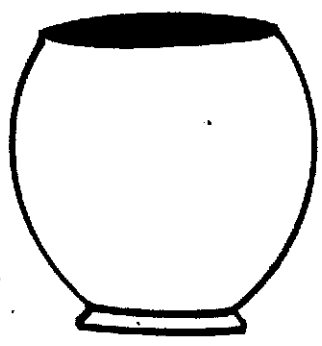
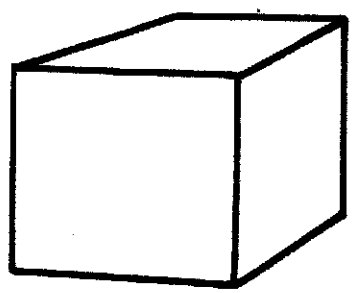
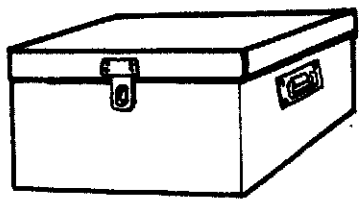
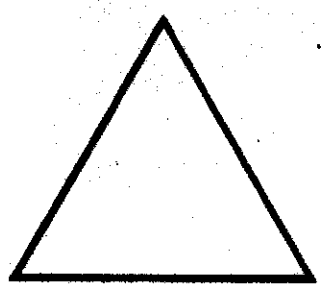
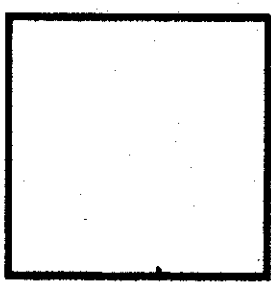
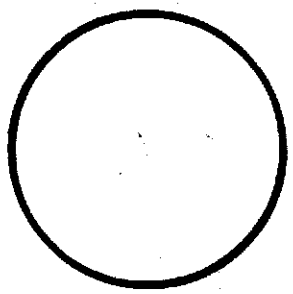



**Art**

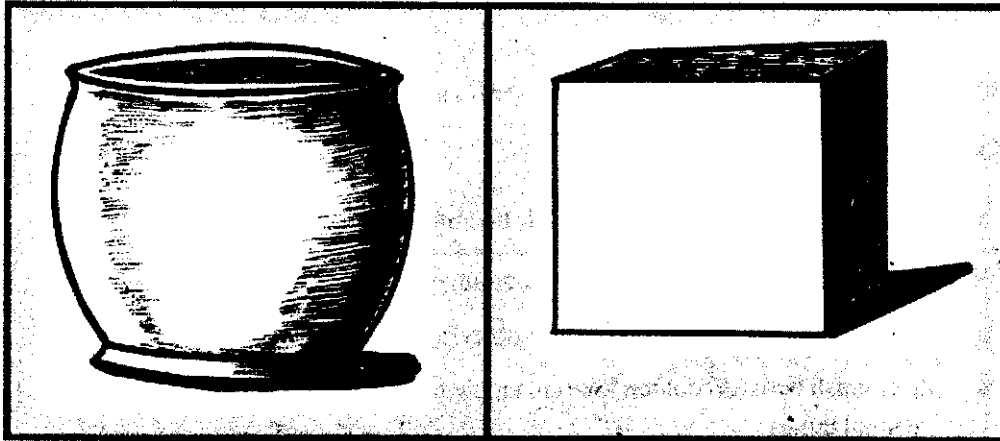

*Use of light and shade on basic shape*



*Use of light and shade on basic shape*

**Draw these objects in line, then add shade according to the source of light which will add volume to the objects**

## 2

# Practical

**Aim – To Differentiate between the man made and natural objects.**

### Objectives

On completion of this Practical, you will be able to:-

- differentiate between animate and inanimate objects.
- identify the man made and natural objects.
- distinguish between colour, texture, tactile quality and material in man made and natural things.

### Select

*Select man made object (Jar, plate, vase) and natural objects, (flower, vegetable, fruits.)*

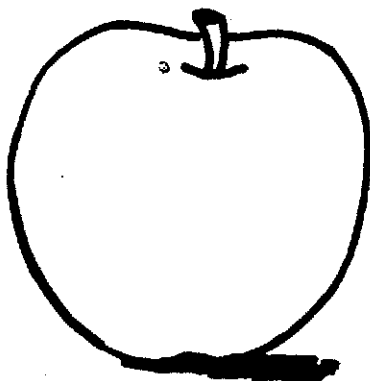

*Preliminary drawing*

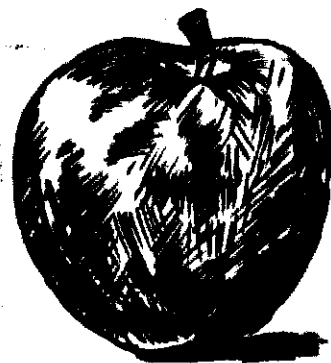

*Use light and shade*

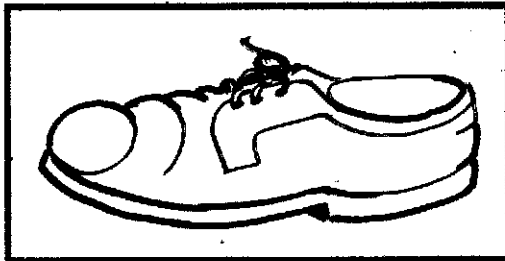

*Preliminary drawing of man made object*



*Shading of the object*

**Arrange group of objects (man made and natural) in front of you. Draw in line, then add**

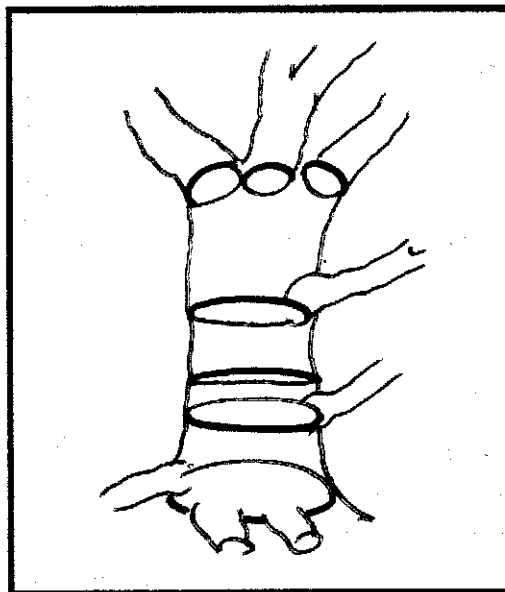

*Preliminary drawing*



*Shading of the object*

**Relationship between manmade and natural — give importance to relationship of proportion between these objects**



*Manmade object*



*Natural object*



*Natural and Manmade objects*



# 3

## Practical

**Aim – To Use light & shade to achieve volume and depth in terms of perspective**

### Objectives

On completion of this Practical, you will be able to:-

- Define foreground, background in the pictorial space
- Establish the distance between the objects.

### Perspective

Divide the pictorial space to define the foreground and background by drawing a horizontal line.

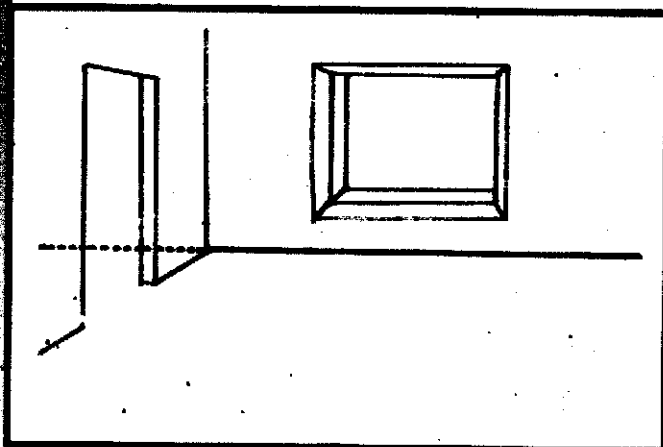

*Foreground and Background*

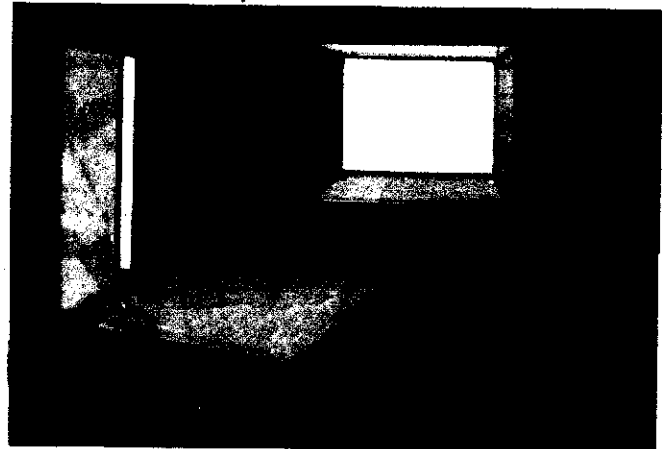

*Perspective with warm and cool colours*

**Wall is the background and floor is the foreground.**

- The objects drawn in the picture at the bottom become bigger and same objects nearer to background appear smaller.

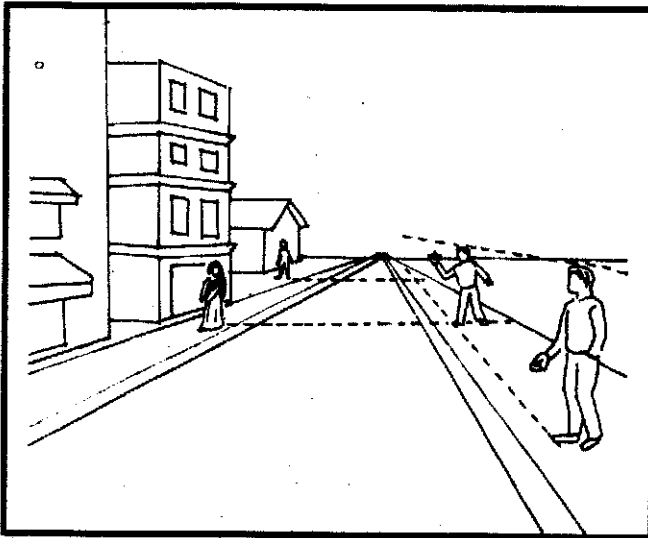

Object bigger in foreground

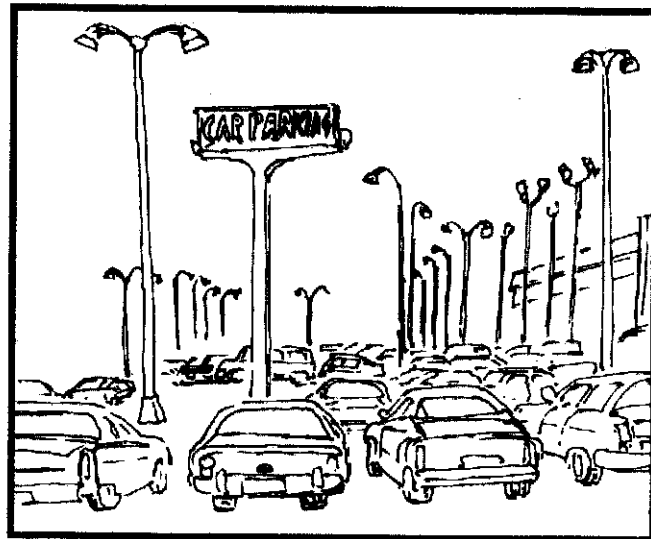

Vertical lines shorter in the background

- Colour :- perspective can be shown in terms of colour by using cool and warm colours of different tones.



Perspective with warm colours



Parallel lines meet in the Horizon



Perspective with cool colours

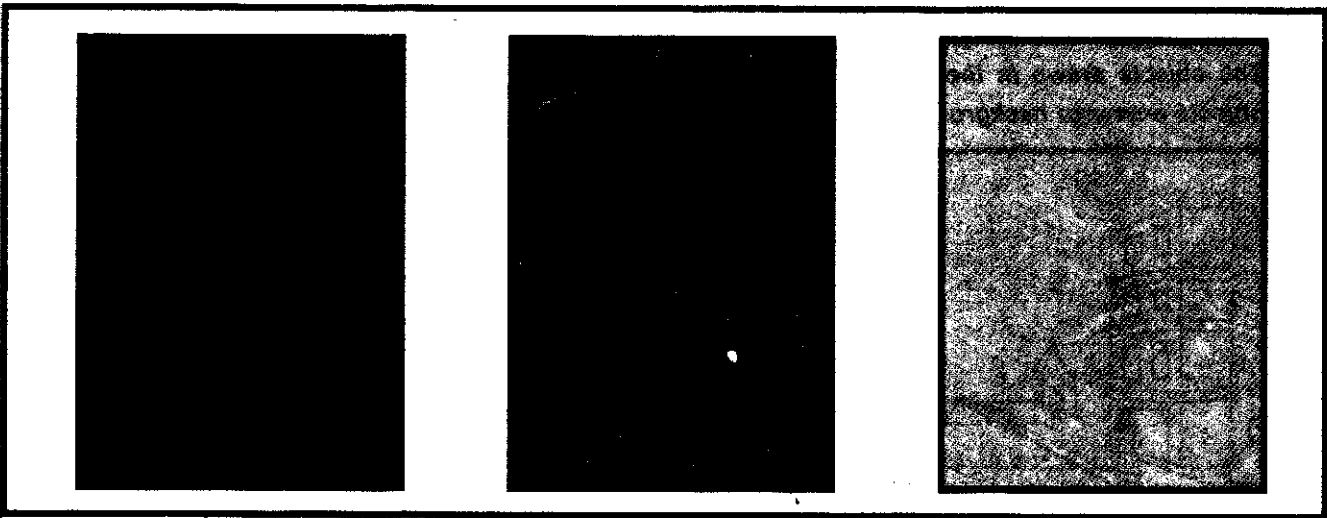

Red

light

lighter

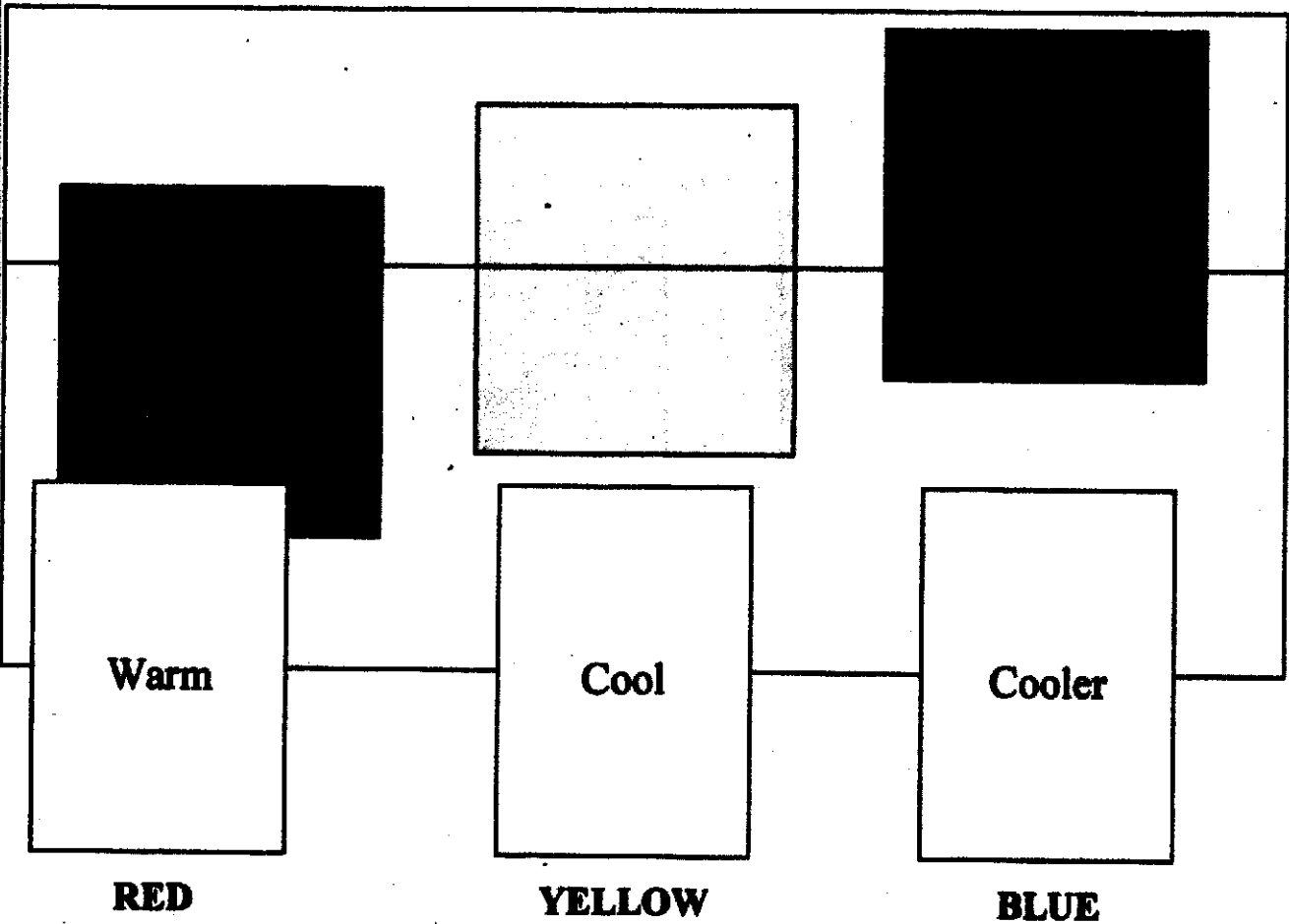

Warm

Cool

Cooler

**RED**

**YELLOW**

**BLUE**

*Study of shapes, manmade and natural objects, relation of proportion, light and shade, volume in terms of colours and perspective will be useful for further studies in composition.*

# 4

## Practical

**Aim :** To study rhythm, harmony, balance and texture.

### Objectives

On completion of this Practical, you will be able to:-

- Compose the picture with rhythm, harmony, balance and texture.
- Create an appealing picture by use of rhythm, harmony and texture.

### Application :

- Repetition of the similar motifs create a rhythm in the picture.

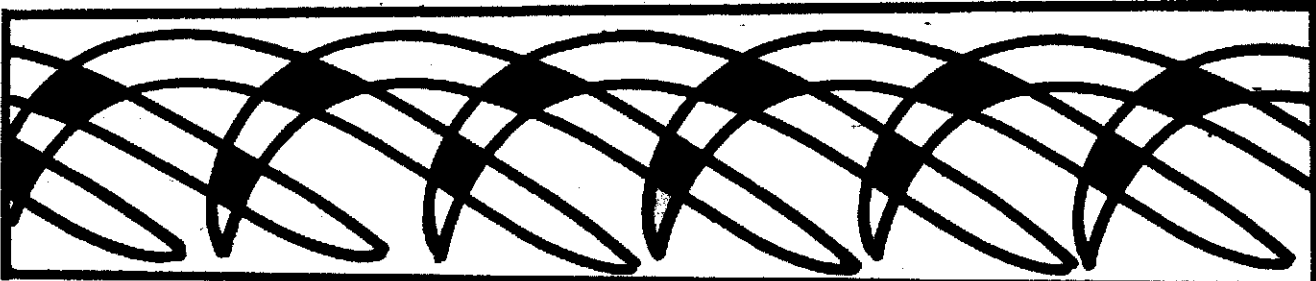

*Structure of Rhythm*

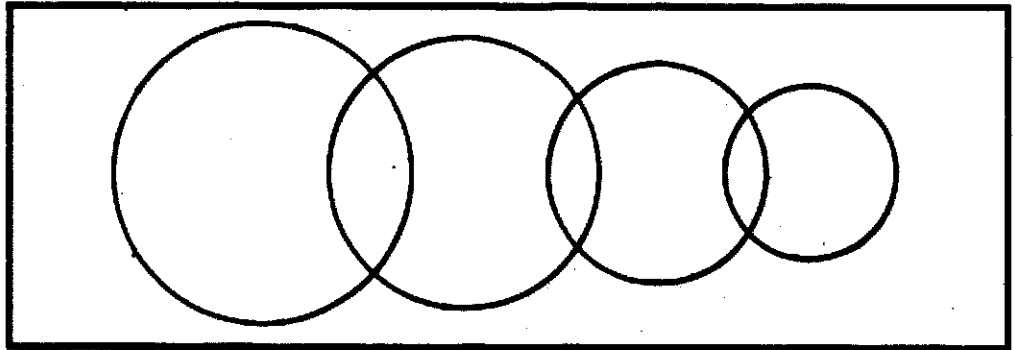

*Structure of Rhythm*

- Different motifs are used to create a particular unit that is called harmony.

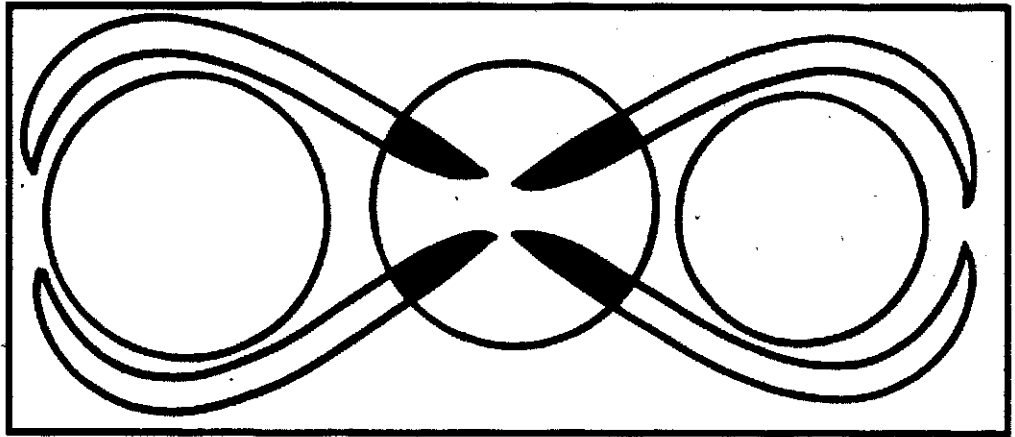

*Structure of Harmony*



*Harmony*

- *Uses of different motifs to maintain the equal weightage in the pictorial space, is called balance.*

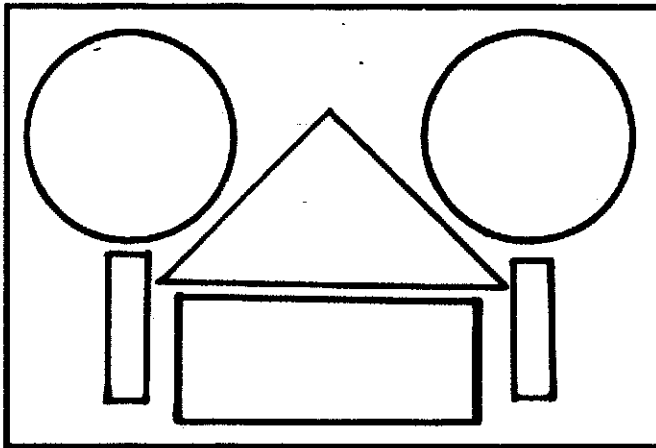

*Structure of Balance*



*Composition with Balance*

**Texture :** *It is a technique by which different sensual feelings are given on the picture surface.*

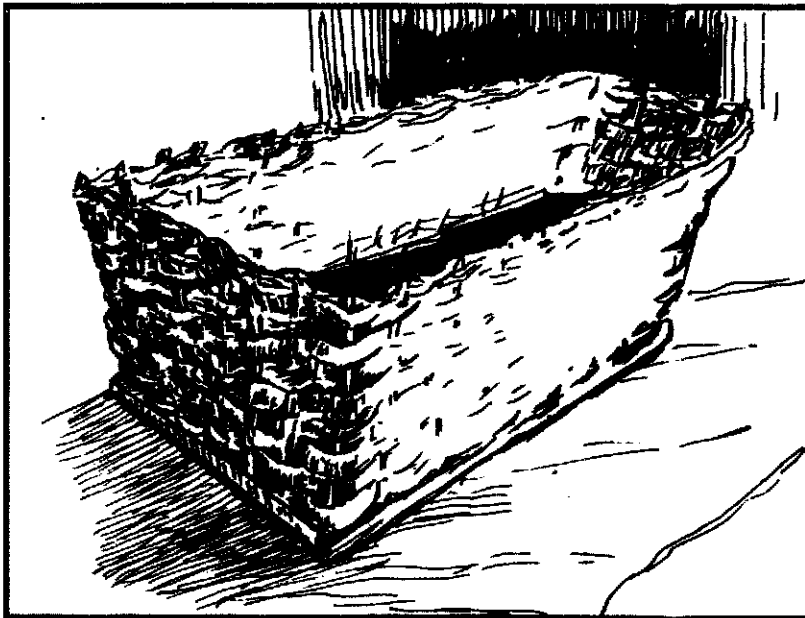

*Texture*

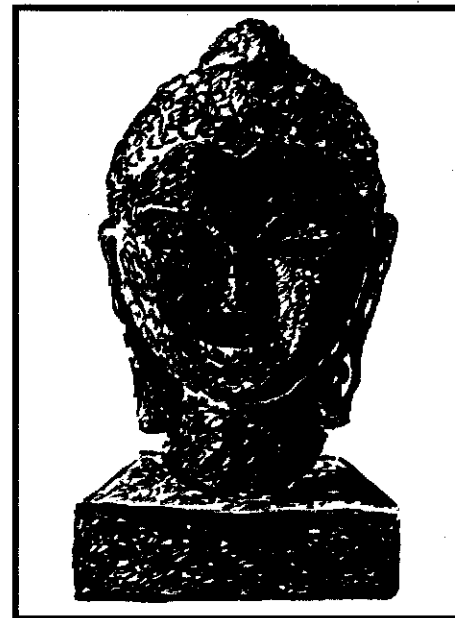

*Texture*

**Example :-** A texture could be achieved by using thick pigments or scratching or brushing in a particular way. Drawing utilizes hatching scribbles, dots etc. to create variety of textural effects.

Arrange a composition keeping in mind a proper application of rhythm, harmony, balance and texture.

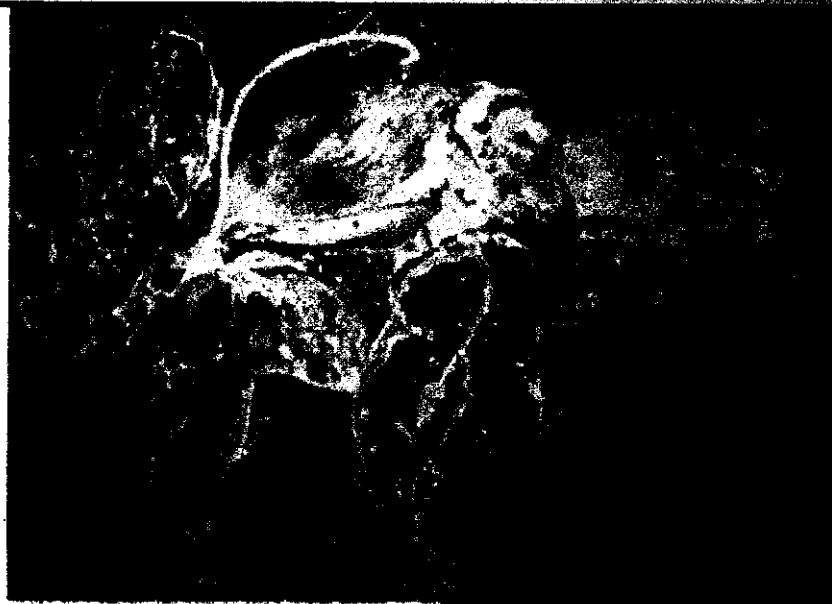

*Composition with Rhythm, texture and harmony*



*Vincent van Gogh Night Cafe, 1888 (89 x 70 cm) New Haven, Conn.,  
Yale University, S.C. Clark Collection*

**To create an appealing picture the elements of rhythm, harmony, balance texture in form and colours are required.**

# 5

## Practical

**Aim - To learn the application of primary, secondary and complementary cool and warm colour**

### Objectives

On completion of this Practical, you will be able to:-

- identify the primary, secondary complementary colours.
- make secondary colours by mixing two primary colours.
- differentiate between secondary and tertiary colours.

### Application

- Apply warm colour red, orange to objects/forms which you want to project and cool colour blue, green, yellow to bring the recession.

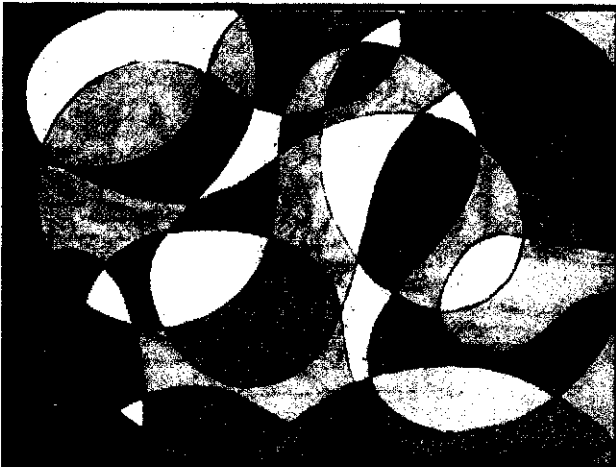





*Composition with warm and cool colours*

- **To paint a very bright picture, preferably use primary colour, on the contrary to get soft effect, use secondary colour.**

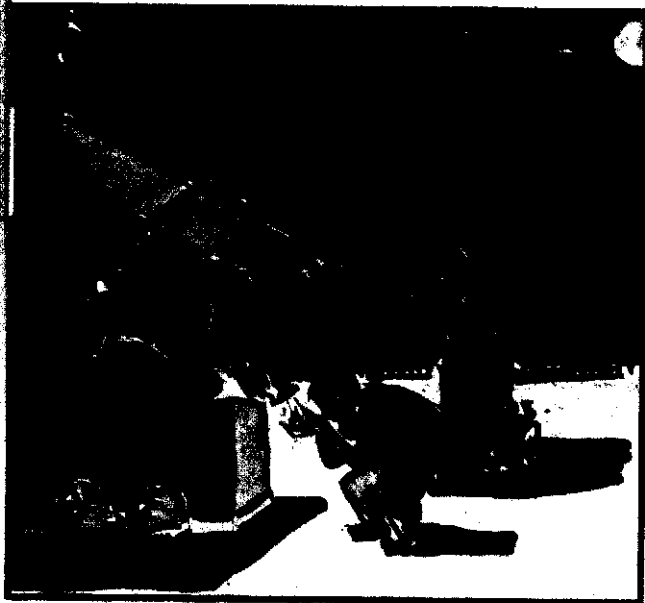

*Summer*



*Winter*



*Rain in secondary and tertiary colours*

- ***A day summer scene or sunrise would be painted by warm, primary colour. Moonlight night, winter season, rain, forest scenes are generally painted with cool and secondary colour.***
- ***Apply different colours in painting according to need and choice which could be both primary, secondary, tertiary colour.***



*Rain in primary and secondary colours*

# 6

## Practical

**Aim – To arrange forms in pictorial space after assimilation of elements studied.**

### Objectives

On completion of this Practical, you will be able to:-

- arrange composition with the studies and sketches of flora and fauna and of man made objects.
- Create a lively atmosphere suitable for the theme of the composition.
- handle different subjects for the composition.

### Select

- Selection of human figure, animal figure, man made objects, trees and natural forms from your reference.

### Arrange

- Arrangement of various elements from your reference to create a composition according to the theme.



*Village scene*

1. human figure, animal figure structure , trees and vehicles
  2. pollution :-  
buildings, factories, smoke, trucks, city road, river etc.
- to create a composition above elements are to be arranged to bring a convincing atmosphere in a pictorial space.



*Air pollution*



*Water pollution*



*Noise pollution*

1. mother taking her child to school in the rain
2. commuters are waiting at the bus stop in the rain.

**Arrange a composition with the following elements**

- a) man/woman figure or child (boy/girl)
- b) dog/cow etc.
- c) falling rain
- d) man and animals
- f) falling rain



*Composition with human figures*



*Composition with animals*



*Composition with nature*



*Composition with nature, man and animal*

# 7

## Practical

**Aim - To create a composition to express feeling and emotion.**

### Objectives

On completion of this Practical, you will be able to:-

- express their emotions and feelings through their pictures.
- create a composition which bears the distinct mood and emotion.

### Application

- learner should try to bring proper expression in the gesture and body language of the figures in co-ordination to inorganic elements.



*gesture and body language*



*gesture and body language*



- **The flow of line application of the colours, and texture should be used in such a manner that desired emotions and feelings are properly expressed.**



*Mother and Child*

Motherly love could be expressed through the gesture in lips, eyes and soft touch of hand.

- *The festive mood could be expressed by gestures like raised arms, smiling faces – each other in a very bright and warm colour composition.*



*Deepawali*



*Eid*



*The great boat race festival of Kerala*

- *The composition should reflect the same mood on the viewers to enjoy the painting, That is the success of your creation.*

Different moods could be used like



*Cry*

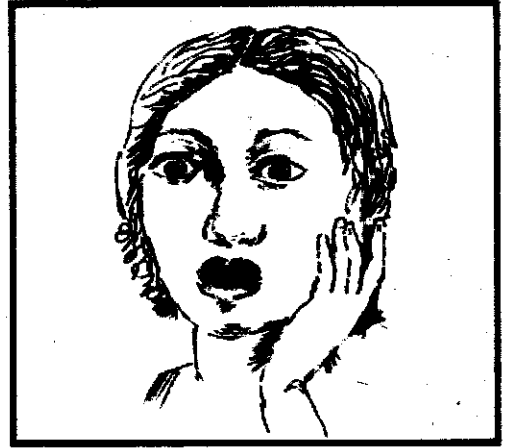

*Wonder*



*Smiling face*

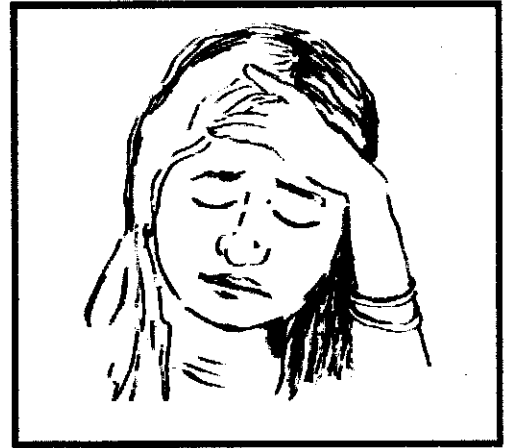

*Sadness*



*Mirth*

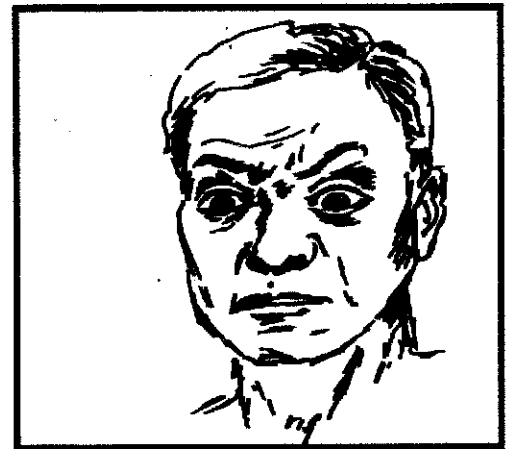

*Anger*

# 8

## Practical

**Aim - To document the visual experience by sketching and studying the different organic and inorganic forms.**

### Introduction

Visual experience is to perceive forms by seeing and understanding the different aspects of forms. This could be manifested in visual shape by sketching and drawing.

### Objectives

On completion of this Practical, you will be able to:-

- differentiate between study and sketch.
- handle the drawing materials to express the movement and characteristics of the forms.
- document the mood and atmosphere in the sketch and study.

**Select :-** Racing animals, spring seasons, playing with the pets.

## Arrange and Draw

1. Select a sketch of a dog and a cat from your documentation. Draw the cat running away in the background and dog in the foreground chasing the cat.

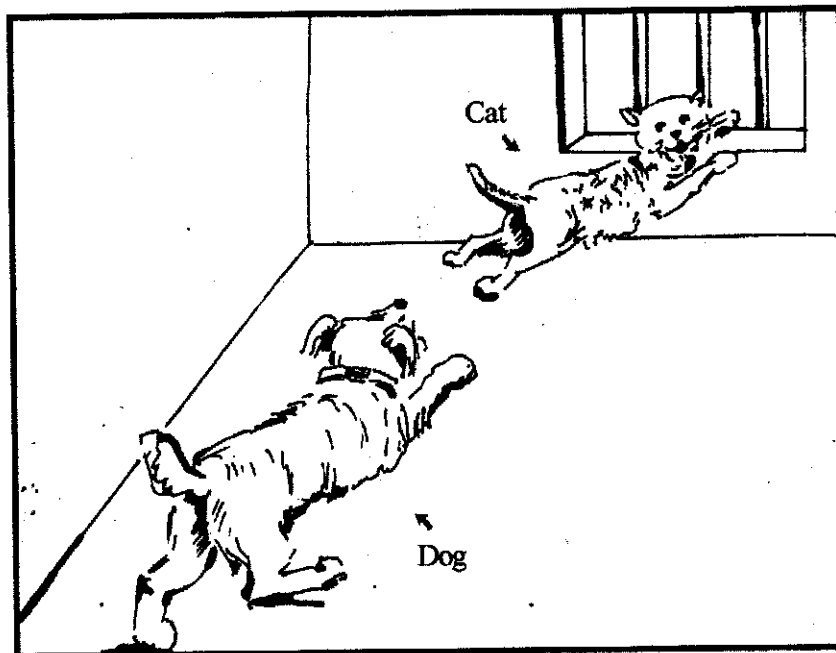

*Dog chasing the Cat*

2. To express the love for pets, draw any pet animal with a human figure caressing it.



*Playing with pet*

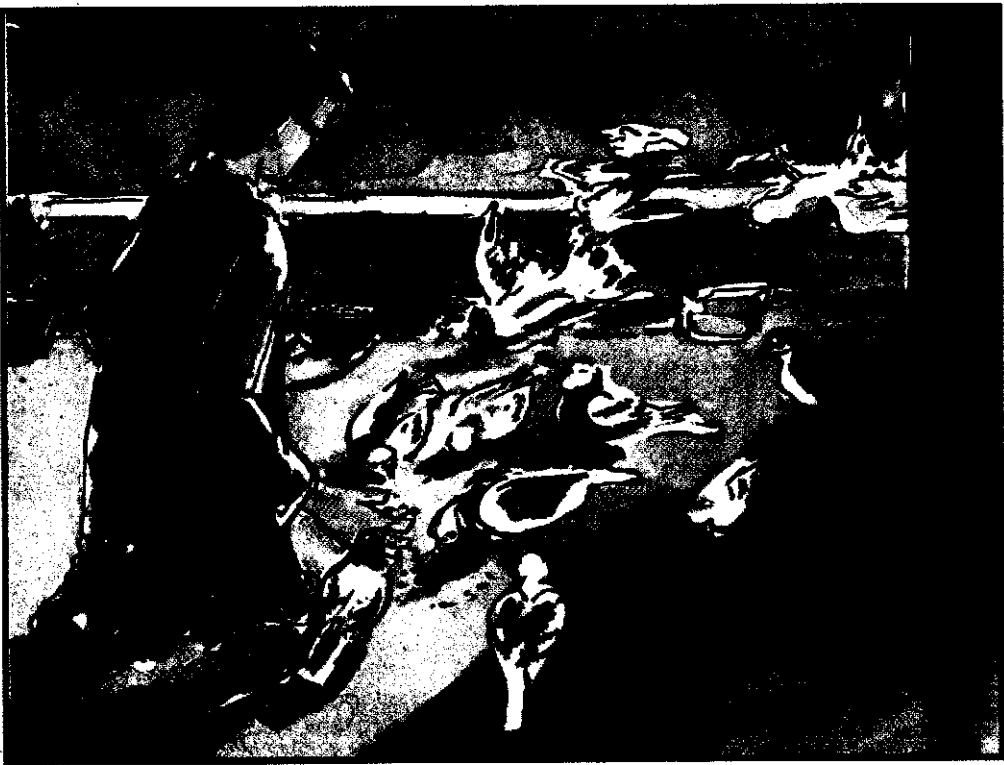

*Feeding the Pigeon*

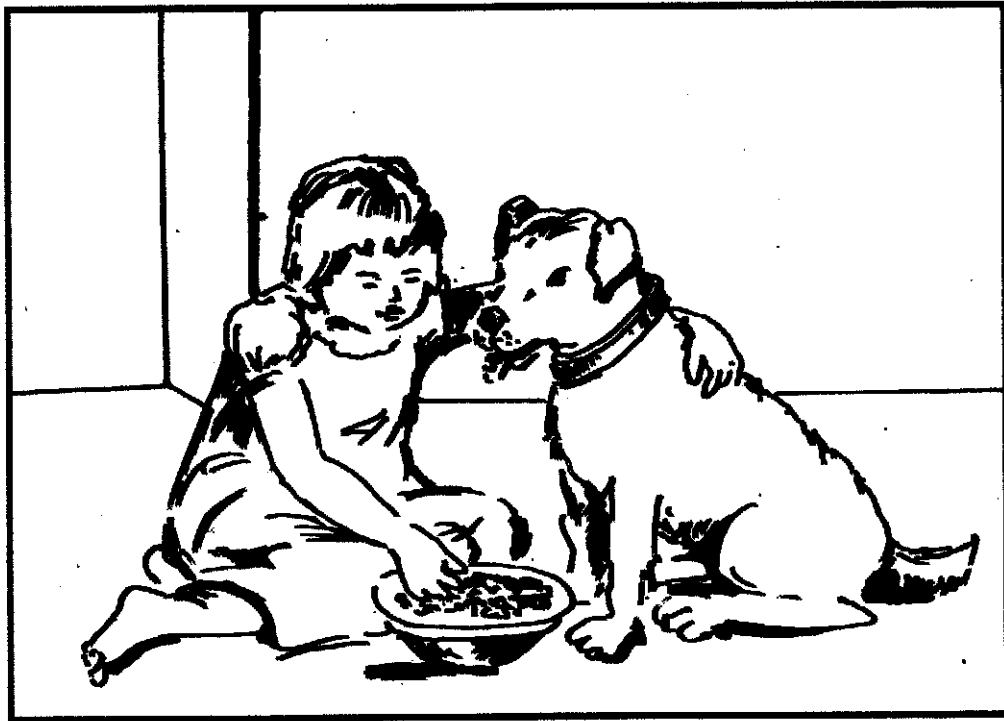

*Feeding the dog*

Try to document as more as possible by sketching and studying.

# 9

## Practical

**Aim – To manifest forms from stored perception of studies of visual experience in the memory.**

### Introduction

Since art is an expression of idea, it is very important to give tangible visual forms to those ideas in terms of lines and colours.

### Objectives

On completion of this Practical, you will be able to:-

- Create various themes from the memory and documentation.
- use the visual experience in terms of sketching and studying human figures, animal figures and landscape.
- use the documentation as imaginative forms also from memory.

**Select :-** Election campaign, Marriage procession, railway station, pollution.

**Arrange and draw**

- use the elements that you have visually experienced during election campaign in your locality and on the T.V.,
- use the suitable forms from the documentation,
- arranging from these source, create a good composition.

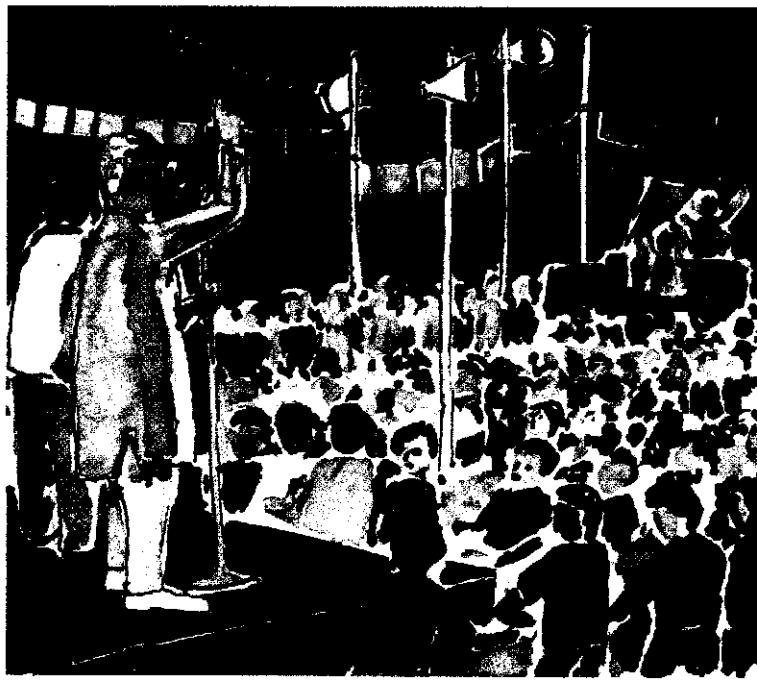

*Election campaign*



*Marriage procession*



*Railway station*



# 10

## Practical

**Aim - To study traditional folk motifs and to understand its importance in Indian art.**

### Introduction

Traditional art form of India and folk art are the best examples of traditional Indian art. We can find different types of folk art in different regions of its own style and character.

### Objectives

On completion of this Practical, you will be able to:-

- differentiate between many forms of folk motifs.
- use all these motifs according to their choice to create their own designs and paintings.

### Select

Madhubani painting from Mithila (Bihar), Kalighat Painting from Kolkata (West Bengal), Phad painting from Rajasthan, and Kalamkari from Andhra Pradesh.

### Arrange and draw

- Collect an original or a print of the specific folk painting and study carefully the motif used in it.

- Select your choiceable motif, re-arrange and re-compose to suit your individual style.
- You can add some external elements to make your own composition.

**Main characteristic features of Madhubani Painting :**

- double contour line joined with horizontal lines.
- faces always in profile and the torso in frontal
- posture.
- space are filled with limited range or colours.
- no space is left vacant in the picture.

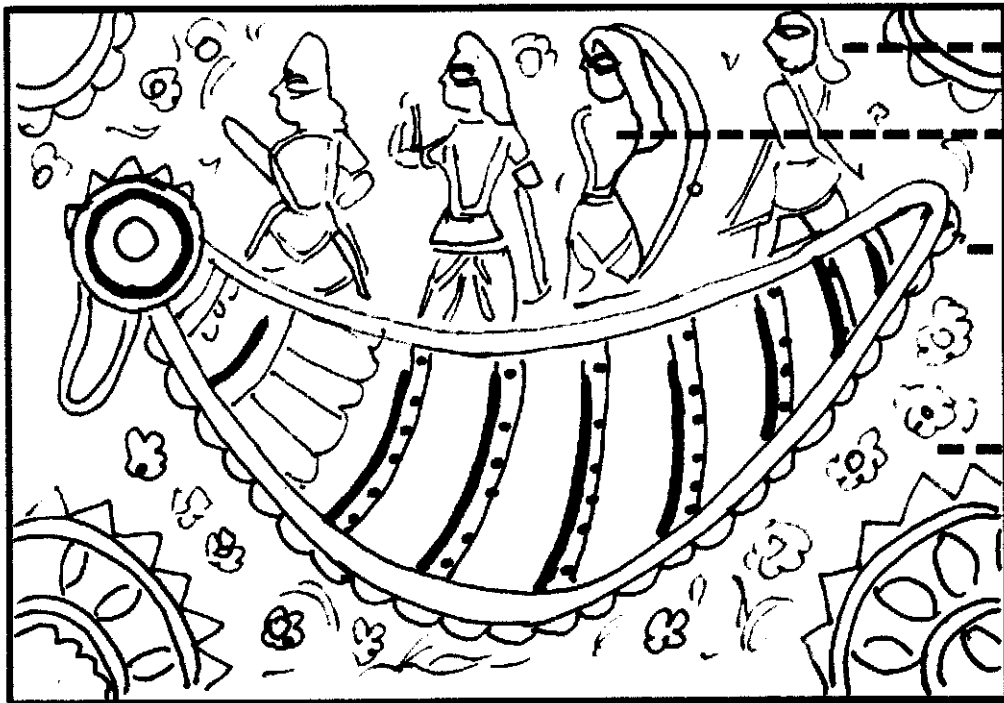

Face in Profile

Torso Frontal

Double Contour

No Space Left Vacant

**Elements of Madhubani Painting**



*Stylish forms*

*Fluent black  
lines*

*Elements of Kalighat Patachitra*

**Main characteristic feature of Kalighat  
Painting :**

- mainly done on cloth and earthen saucer
- mainly done with fluent black lines with brush with stylised forms.
- primary colours like yellow, blue and red are used.

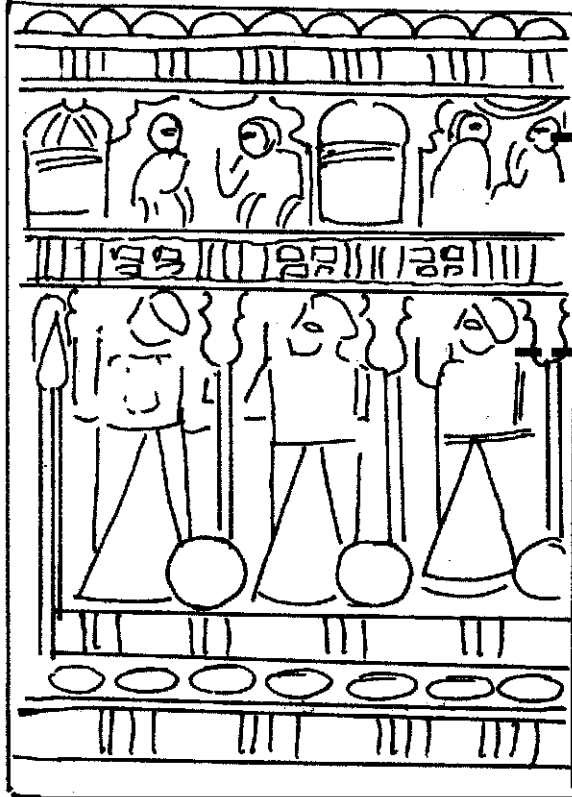

Compositional space divided into square and rectangle

Mainly royal figures

Elements of Phad Painting

**Main characteristic features of Phad Painting :**

- compositional space is divided into many squares and rectangular areas and painted with figures mainly related to royal court and procession.
- colours are very sober and are toned down with grayish value.



Strong outline

Rich Shades

Elements of Kalamkari

# 11

## Practical

**Aim - To study the techniques and materials used by the folk artist.**

### **Introduction**

Style of folk paintings from various regions. Different types of methods and materials are used. These are mainly chosen according to the availability of the materials in the locality.

### **Objectives**

On completion of this Practical, you will be able to:-

- differentiate the usages of methods and materials in folk paintings.
- select the suitable method and material for design and painting.
- add different motifs and techniques for design and painting.

## Madhubani Painting

Madhubani paintings are done by women on various occasions. The rich earth colours, as reds, yellows, indigos and blues are used. The most basic materials – gum, thread and matchsticks or fine bamboo slivers wrapped in cotton are used to execute these paintings.

Nowadays these are also done on hand made paper.

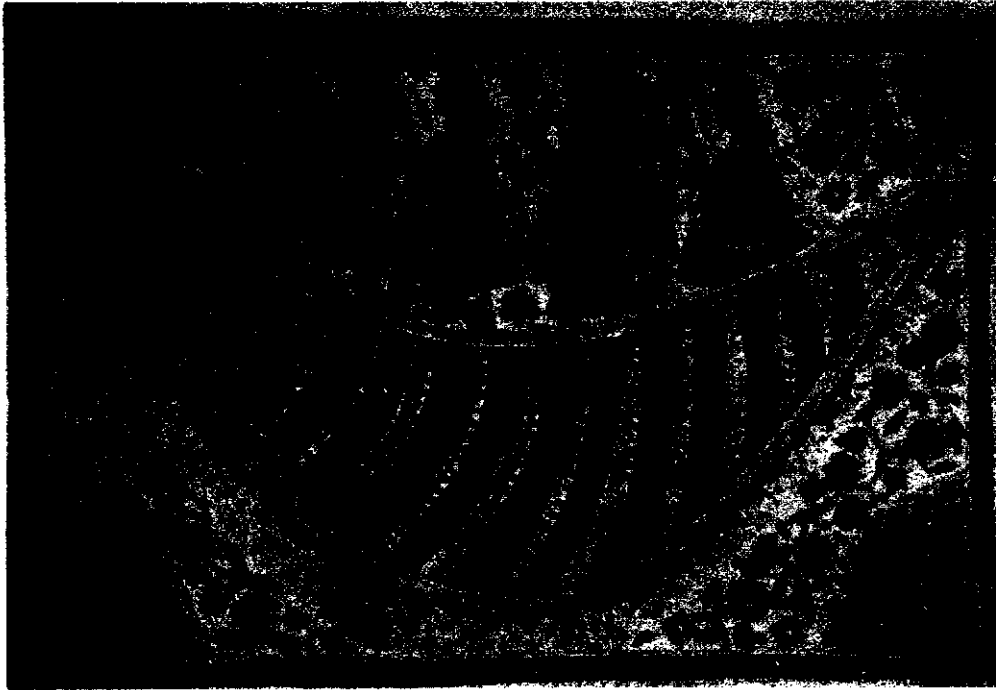

## Warli Painting

The walls are first prepared by cleaning and smearing with a paste of cowdung. When it dries, a coating of gheroo or red mud is added to give texture to the background. Pounded rice mixed with milk and water and red sindur are used as paints, and applied with a brush made from the twigs of trees.

These paintings have recently been rendered on paper to approximate the original textures as closely as possible.

## Phad Paintings

Phad paintings are from Rajasthan. The painting is done on rough handspun, hand woven cloth after it is prepared by applying a thin layer of starch on it and mixing it with the pigments to soften their tones. The outline is worked in contrasting colours on the prepared background.

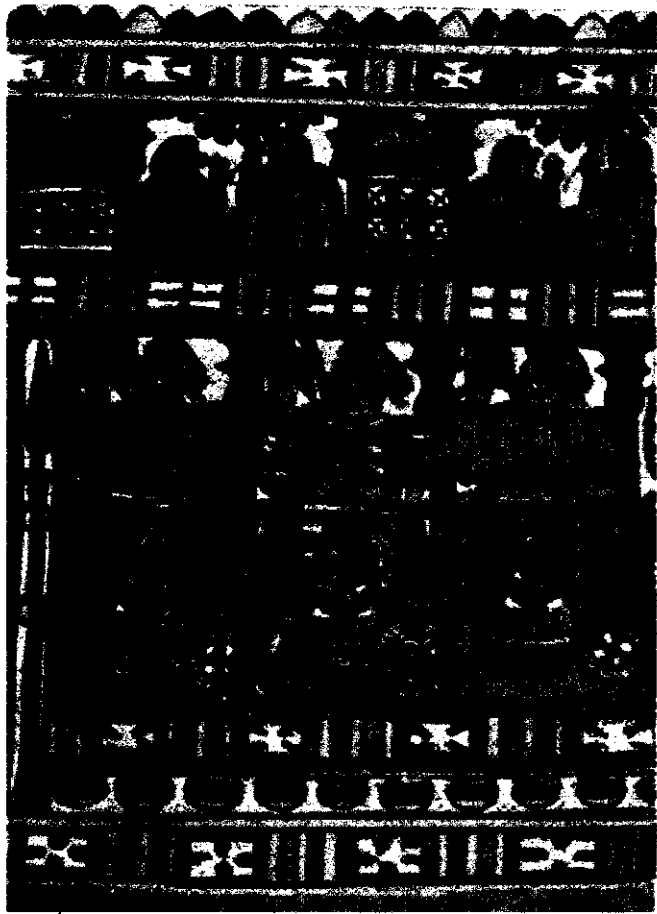

## Kalamkari Painting

Kalamkari painting from Andhra Pradesh. These hand painted textiles are used as tapestries and hangings in temples. Vegetable dyes of deep rich shades are used with strong outline in brown and black. Flowing water is used to clear the starch of the cloth. Myrobalm solution bath is given to make the black dye permanent. The drawing is done by charcoal stick made from tamarind twigs. Final lines are drawn with sharply pointed bamboo stick using Kalam, a mixture of molasses and iron filling.

Artist first fills the background colours, then the figures are done. The red is made deeper by applying alum to the cloth surface. The areas not covered are bleached by the use of alum to enable to take on other colours like blue, yellow, green. The cloth is also dipped in milk solution as it prevents colour from fading.



For more information please visit QR code



[www.bseh.ac.in](http://www.bseh.ac.in)



[contact@bseh.ac.in](mailto:contact@bseh.ac.in)